

India
Art. Nr. 200100
1/7

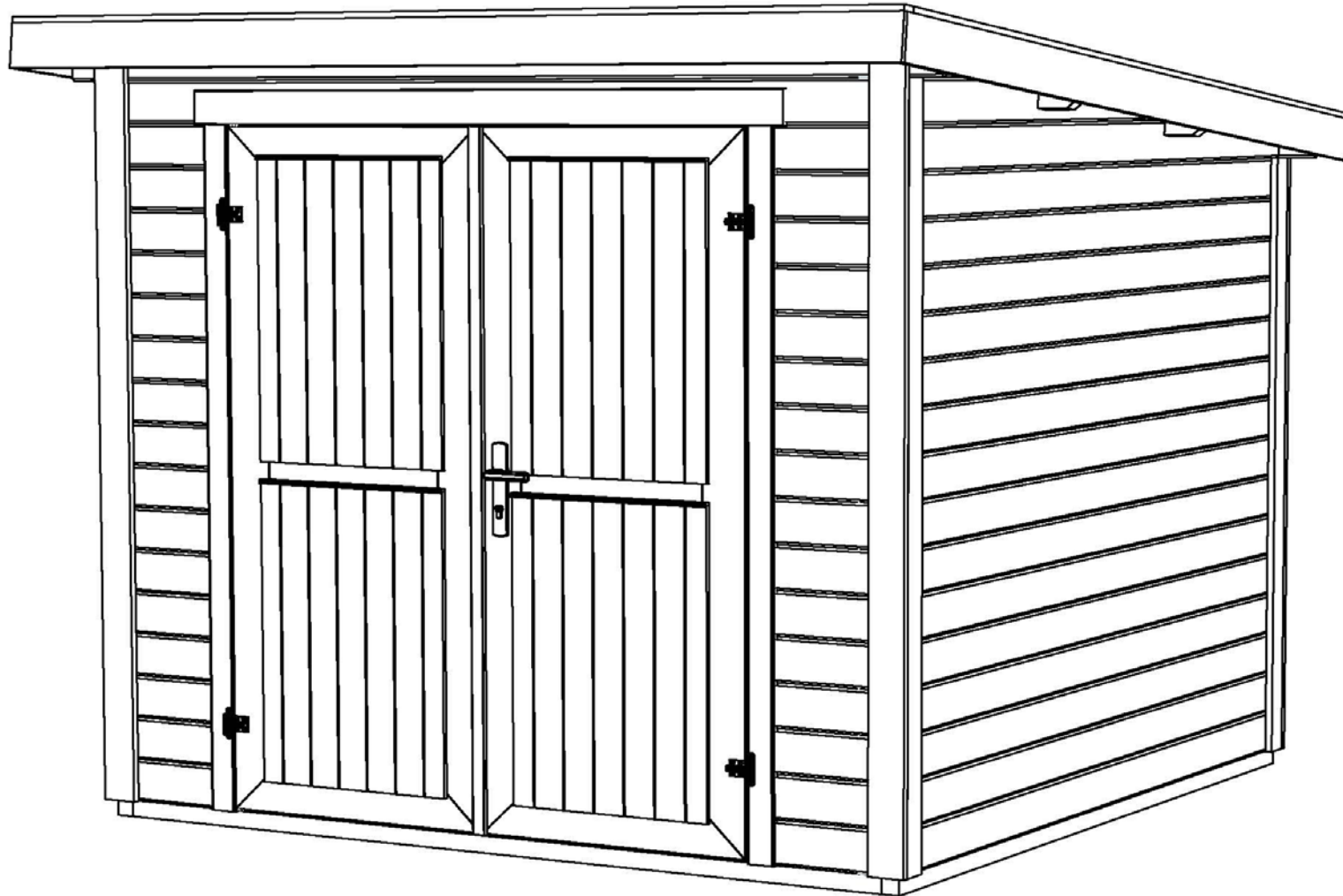

26.06.2019

Grund - Grunnmur - Fundament - Perustus

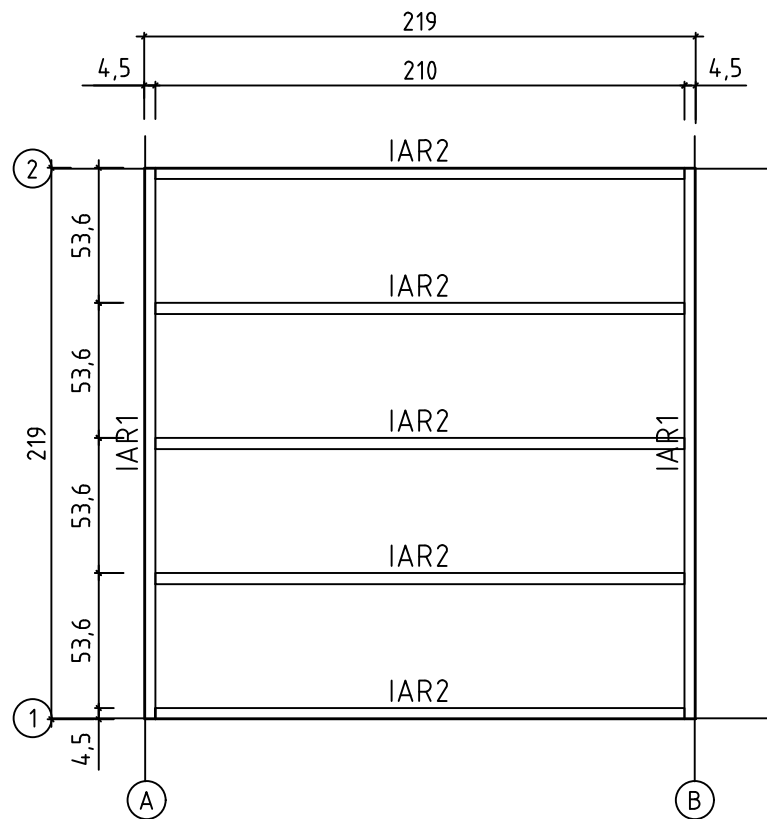

Golvbrädor - Gulvbord - Gulvbrædder - Lattialaudat

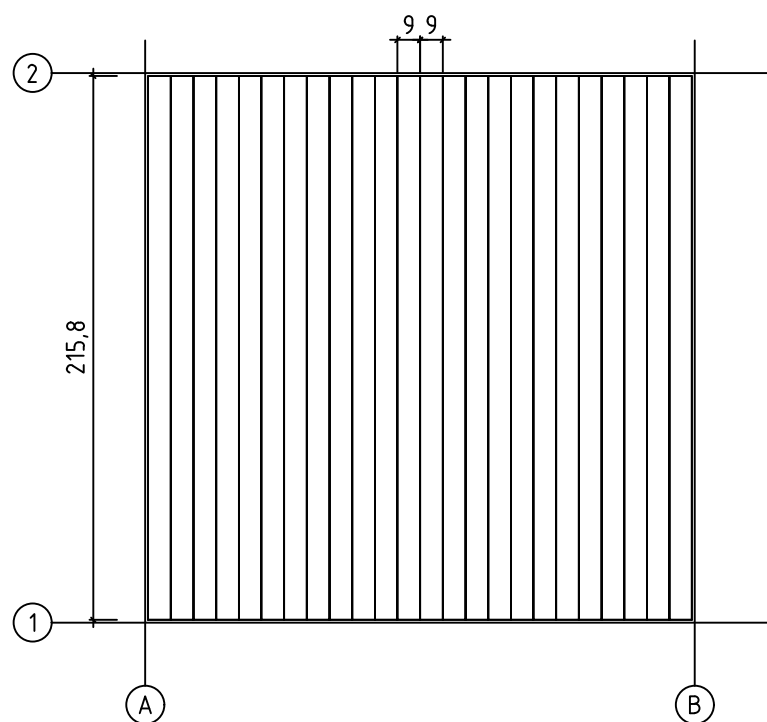

Art. Nr. 200100

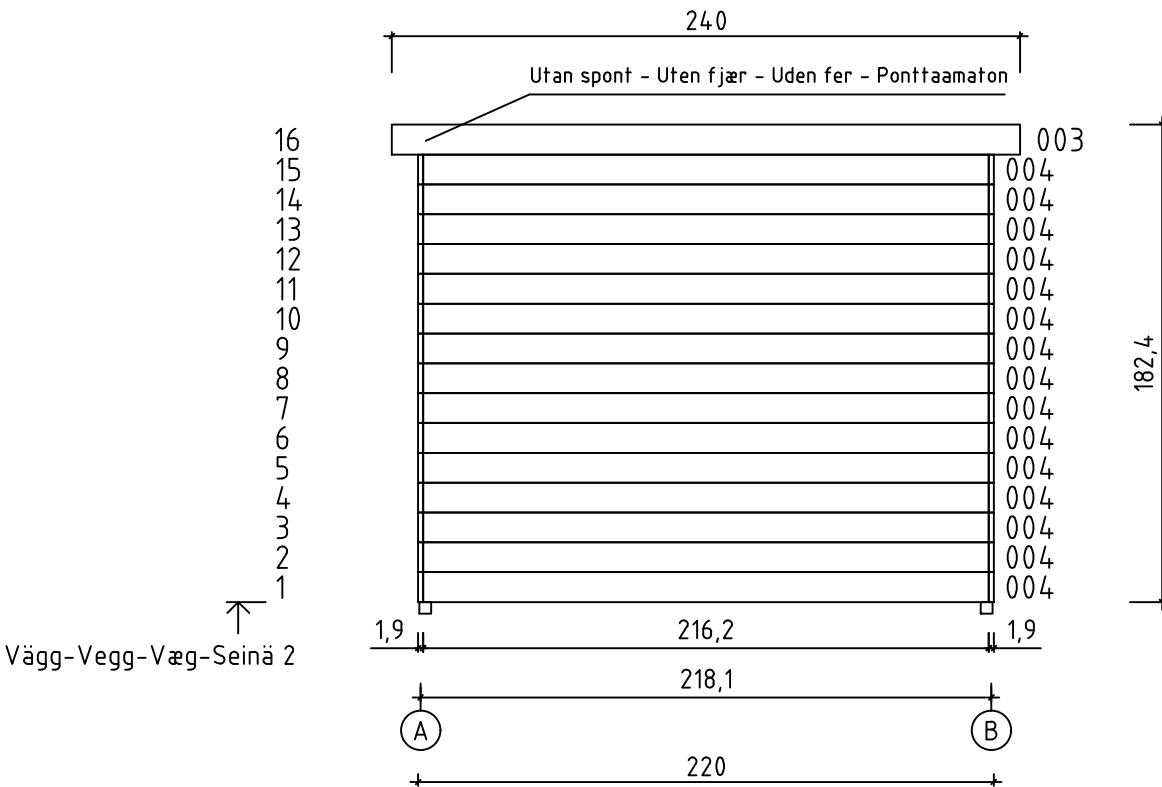
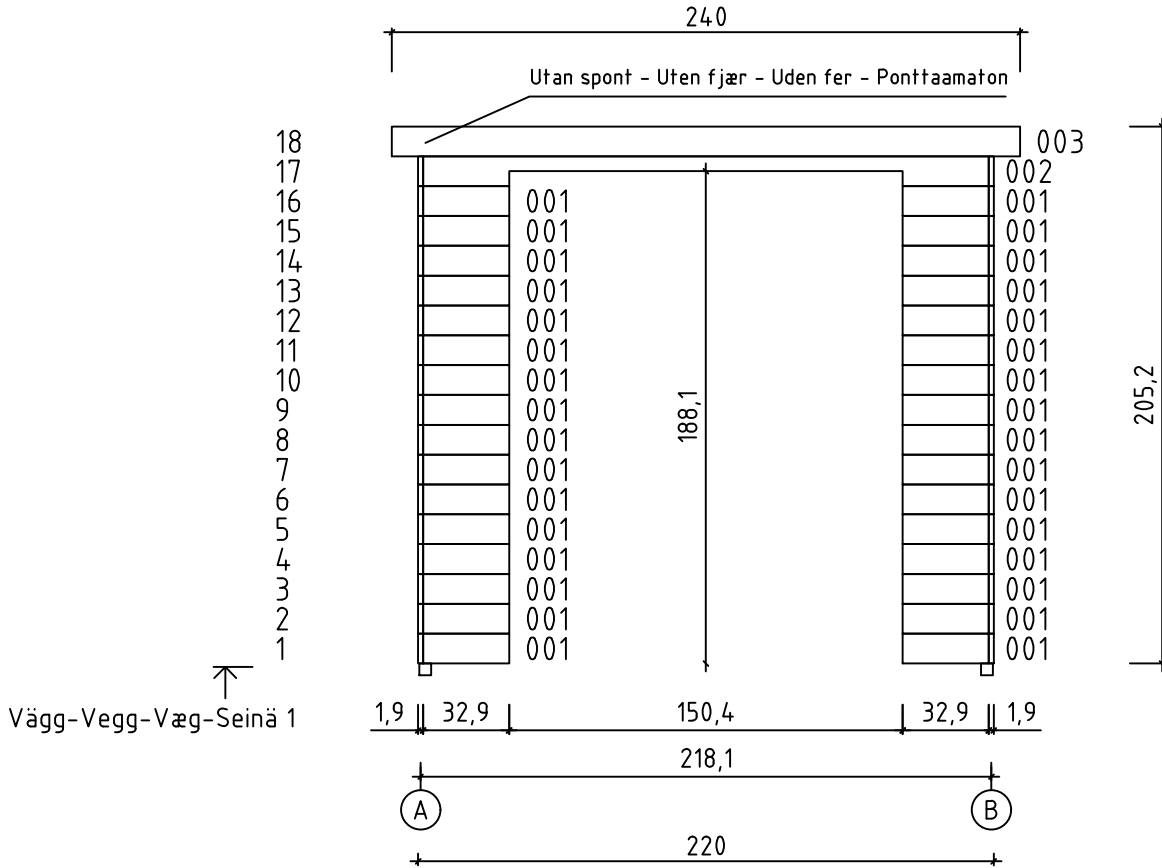





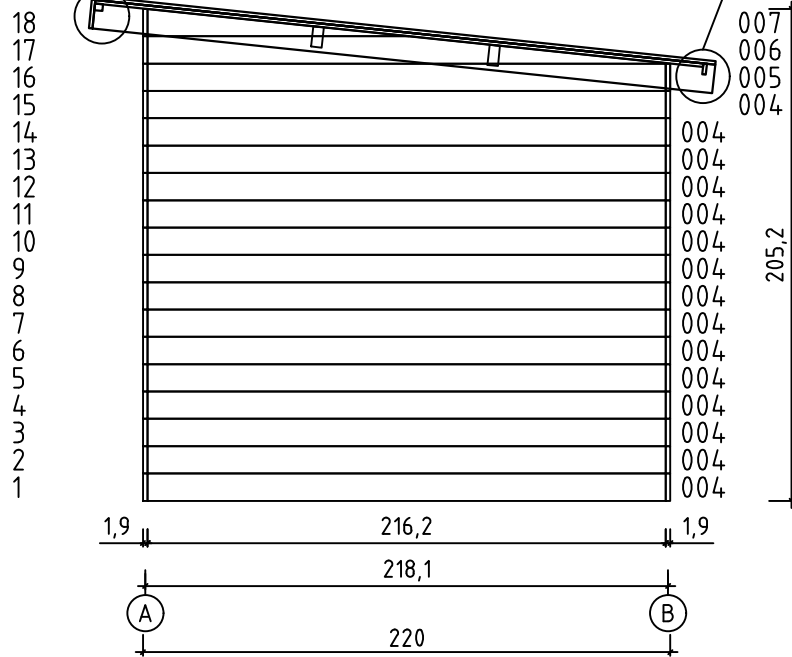



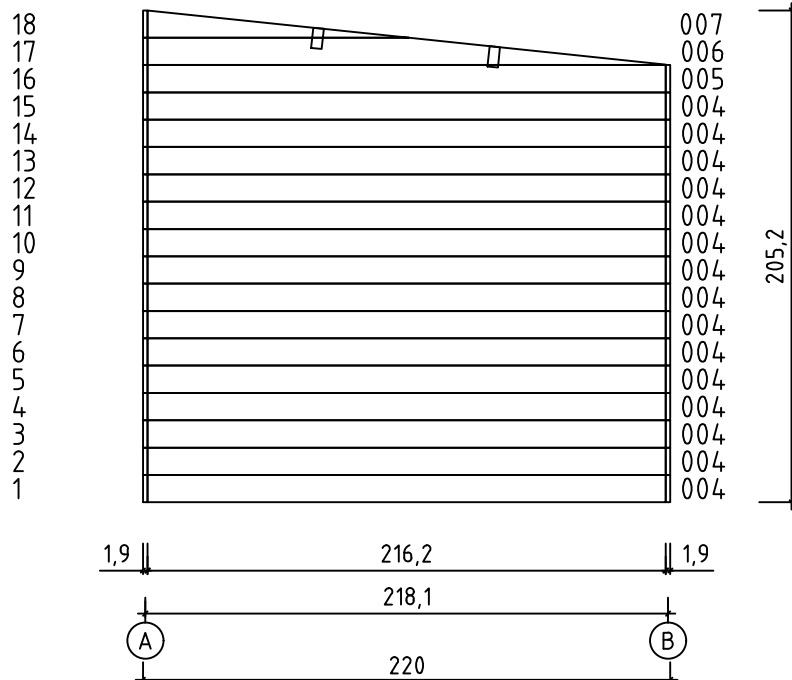



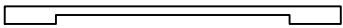
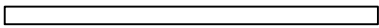
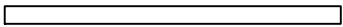
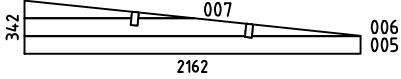
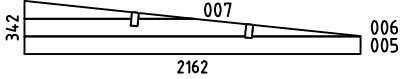

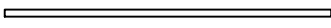
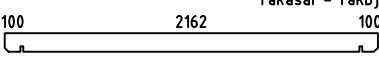





Vägg-Vegg-Væg-Seanä A



Vägg-Vegg-Væg-Seanä B

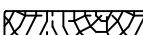

Pos	26.06.2019	Delförteckning - Liste over deler - Stykliste - Osaluettelo Art. Nr. 200100	6/7	Q	P (mm)	L (mm)
001				32	19x114	329
002				1	19x114	2162
003				2	19x114	2400
004				45	19x114	2162
WA-1				1		
WB-1				1		
IAR1		Grund - Grunnmur - Fundament - Perustus		2	45x45	2190
IAR2		Grund - Grunnmur - Fundament - Perustus		5	45x45	2100
A-PR1		Tåkassar - Takbjelke - Tagbjælke - Katto-orret		2	44x120	2400
FB	Golvbrädor - Gulvbord - Gulvbrædder - Lattialaudat			24	90x15	2158
RF	Takbräde - Takbord - Tagbrædder - Kattolauta			27	90x15	2550
FF	Golvläkt - Gulvlist - Gulvliste - Jalkalista				18x18	8.63 j.m.
RFF1	Takläkt - List for takpapp - Tagpapliste - Kattohuopalista			1	15x45	2430
RFF2	Takläkt - List for takpapp - Tagpapliste - Kattohuopalista			2	15x45	2570
CF1	Hörnlist - Hjørnelist - Hjørnedækbræt - Kulmalista			2	15x70	1710
CF2	Hörnlist - Hjørnelist - Hjørnedækbræt - Kulmalista			2	15x70	1938
CF3	Hörnlist - Hjørnelist - Hjørnedækbræt - Kulmalista			2	15x90	1820
CF4	Hörnlist - Hjørnelist - Hjørnedækbræt - Kulmalista			2	15x90	2050
CS1	Vertikal hörnregel - Hjørnestolper - Hjørnelægter - Nurkkapilari			2	44x44	1805
CS2	Vertikal hörnregel - Hjørnestolper - Hjørnelægter - Nurkkapilari			2	44x44	2030
TB1	Takfotsinklädnad - Speilbord - Sternbræt - Rästäslauta			1	15x45	2400
REF	Takfot - Forsterkning av takforkant - Tagkantsforsterkning - Rästäslista			1	28x34	2400
GB1	Vindbräde - Vindski - Vindskede - Kaapelilauta			1	15x120	2430

Pos	11.06.2019	Delförteckning - Liste over deler - Stykliste - Osaluettelo 1494x1850 TUL.2.050.IVP.MXT19 TA+28	1/2	Q	P (mm)	L (mm)
-----	------------	--	-----	---	-----------	-----------

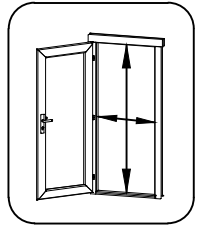
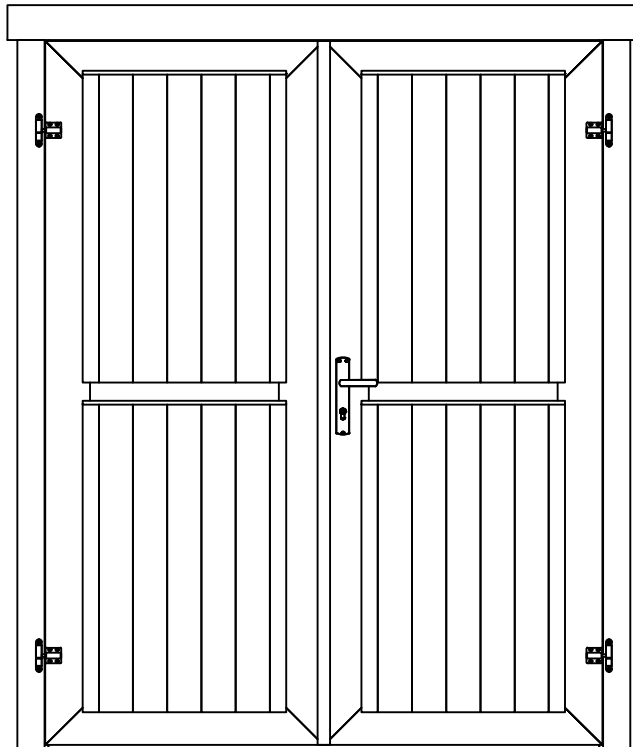

1418x1794 mm

1			1	57x100	1628
2			1	57x80	1850
3			1	57x80	1850
4			1	18x18	1418
5			1	13x32	1812

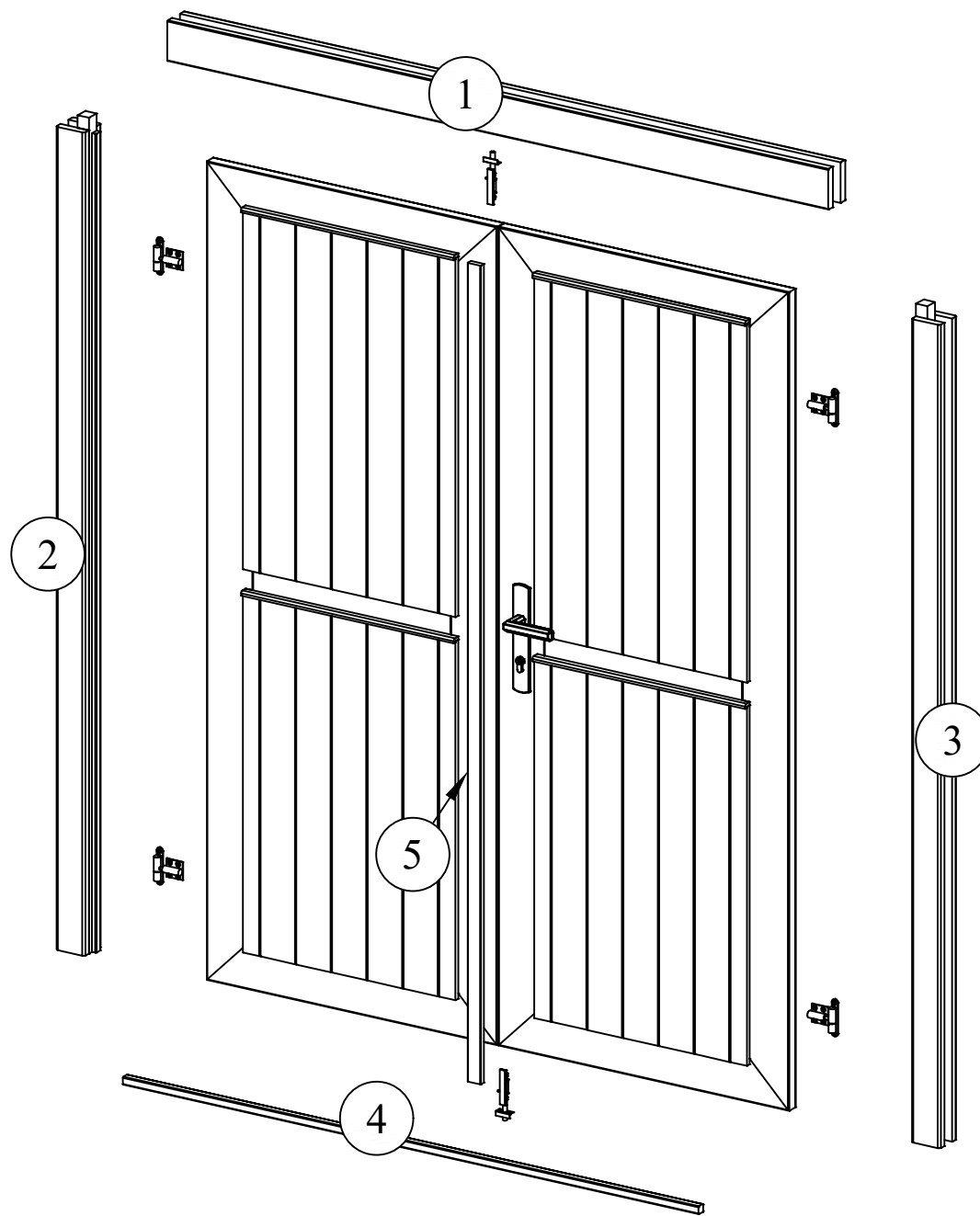

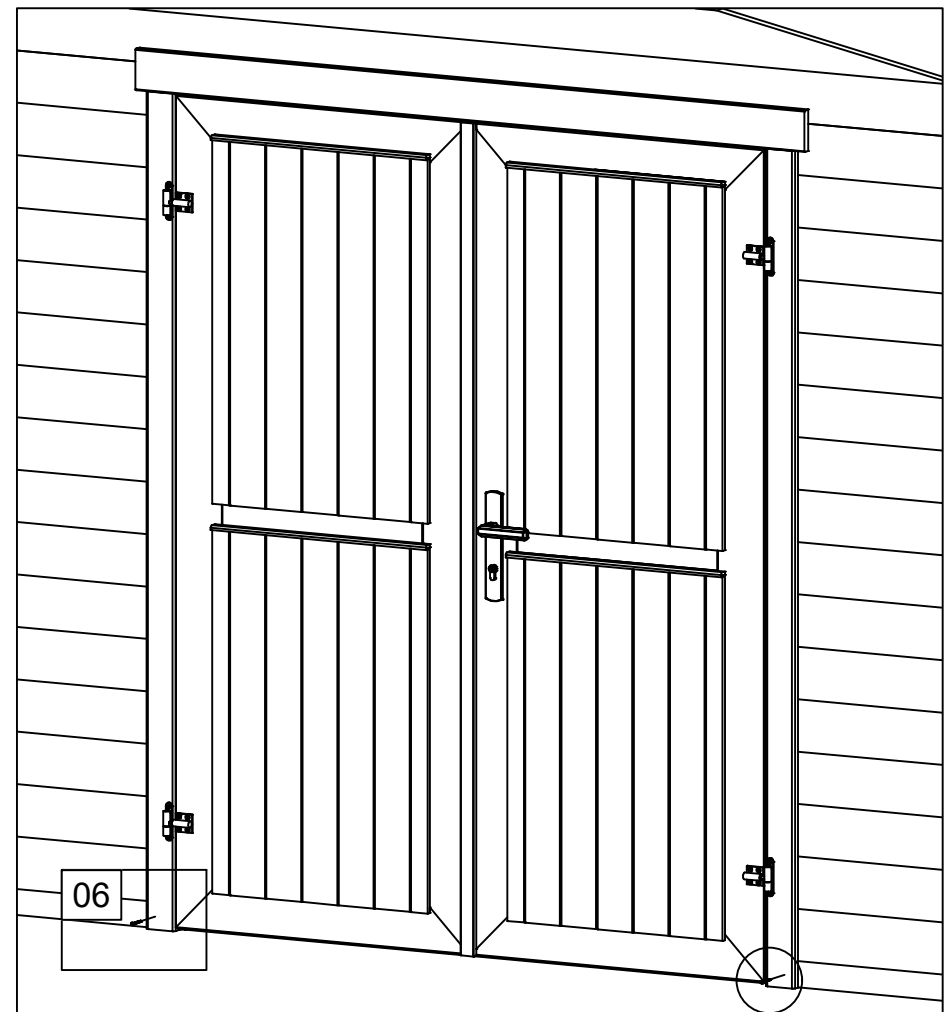
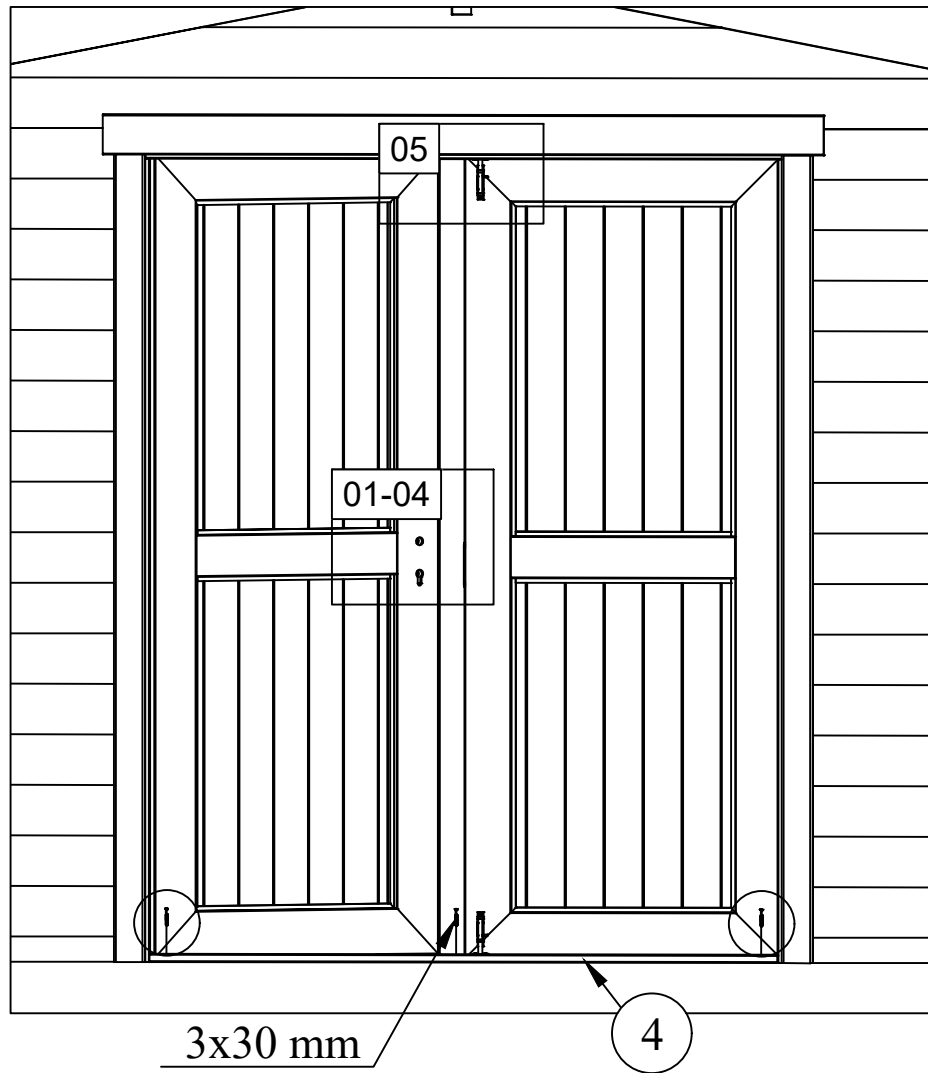

01



04

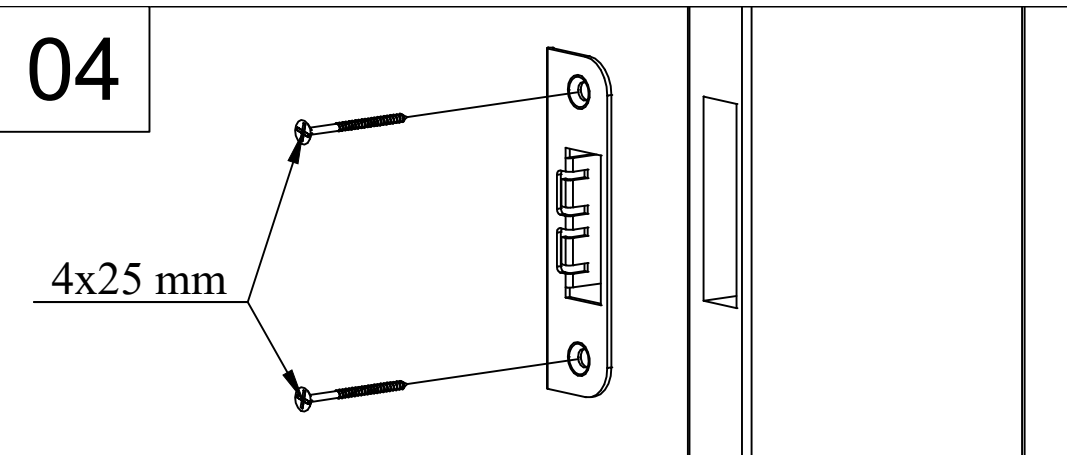

02



05

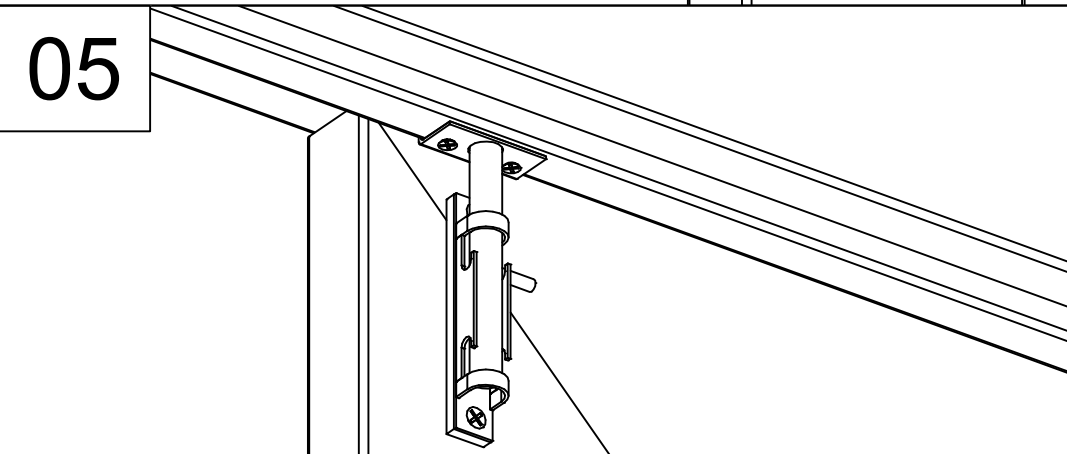

03



06

