

PLUS Plank (varenr. 177005)



www.plus.dk

17772-1 / 17772-15

17773-1 / 17773-15

17774-1 / 17774-15

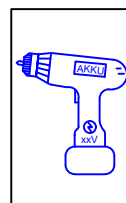
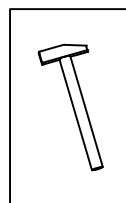
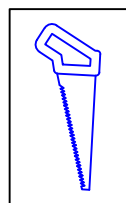
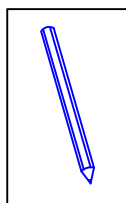
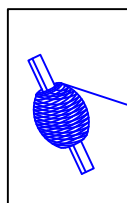
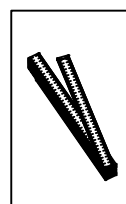
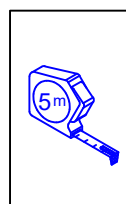
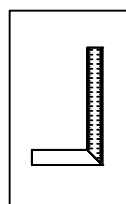
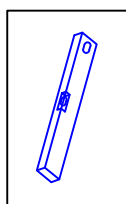
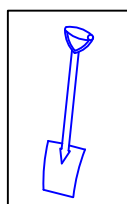

17747-1
17747-15



17748-1
17748-15



17749-1
17749-15

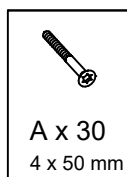

A x 30
4 x 50 mm

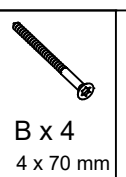

B x 4
4 x 70 mm

17750-1 Skruerpose

- medfølger ikke

17743-1
17743-15



17760-1
17760-15

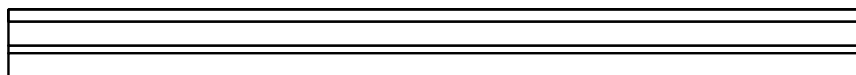

Se montagevideo på www.plus.dk

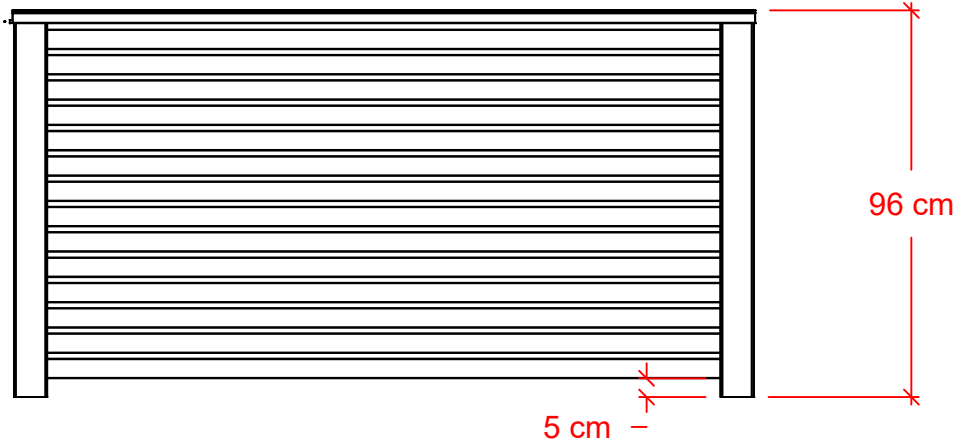

17772-1 / 15

7 planker + topliste

96 cm

5 cm -

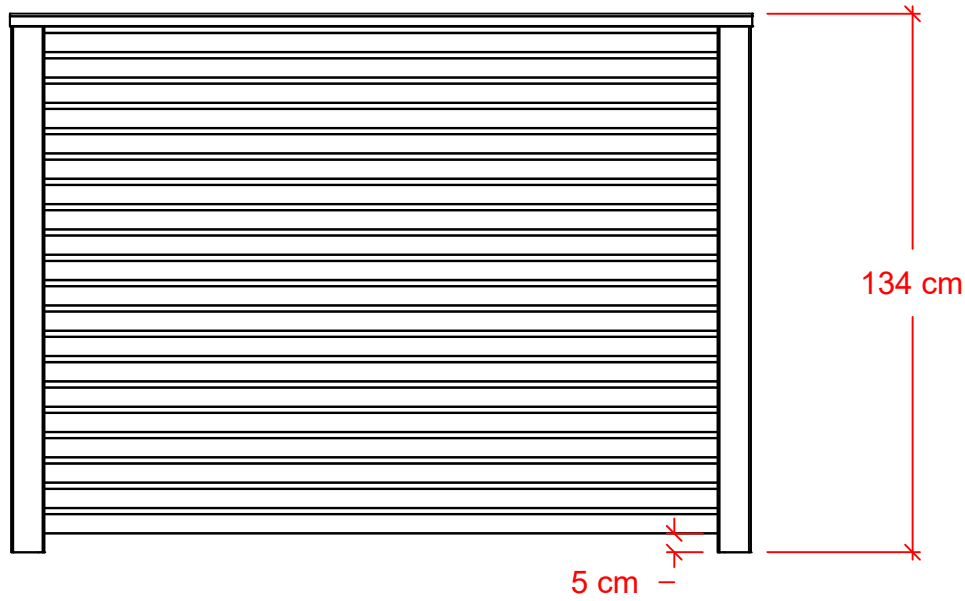

17773-1 / 15

10 planker + topliste

134 cm

5 cm -

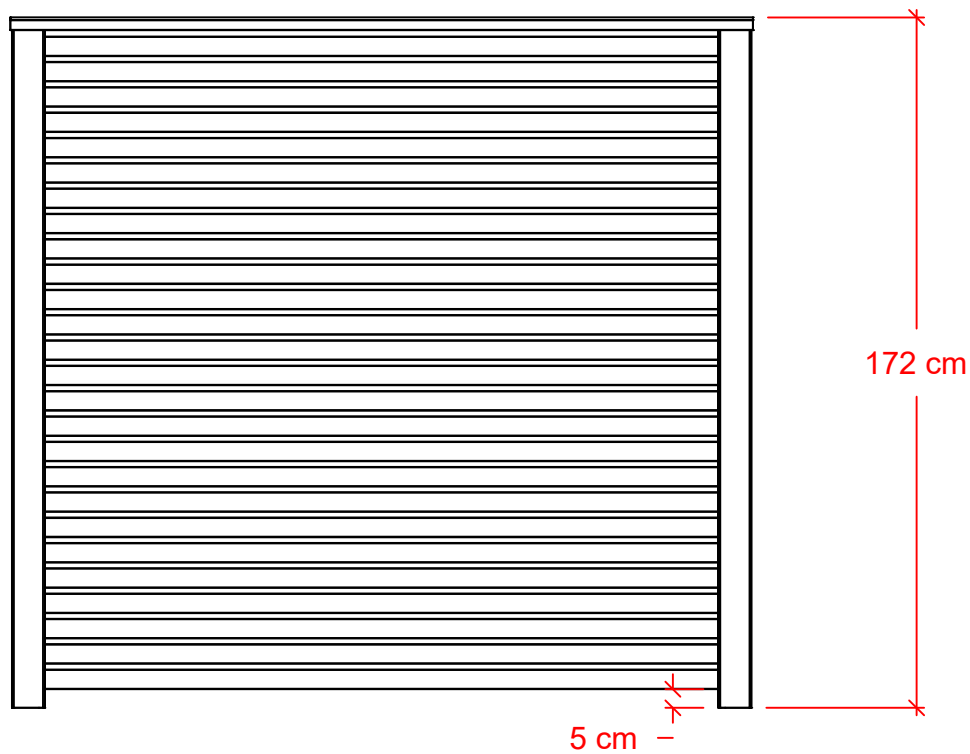

17774-1 / 15

13 planker + topliste

172 cm

5 cm -



Stolper nedgraves 90 cm.

Efter nedgravning af stolper, og før fastskruining af det første bræt. Trækkes der en snor, så man sikrer at brædderne passer ud for hinanden.



Sørg for at nederste planke er fri af terræn. Det vil være en god ide, med ca. 5 cm under det nederste bræt til terræn. (læg evt. en træklods som på billede 1.)



Tjek med vaterpas at brættet er i vatter.



Herefter kan det nederste bræt skrues fast. Med 2 skruer i hver ende. (Skrues skråt ind ved stolpen).

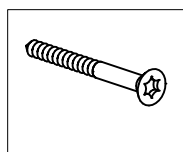

7 planker

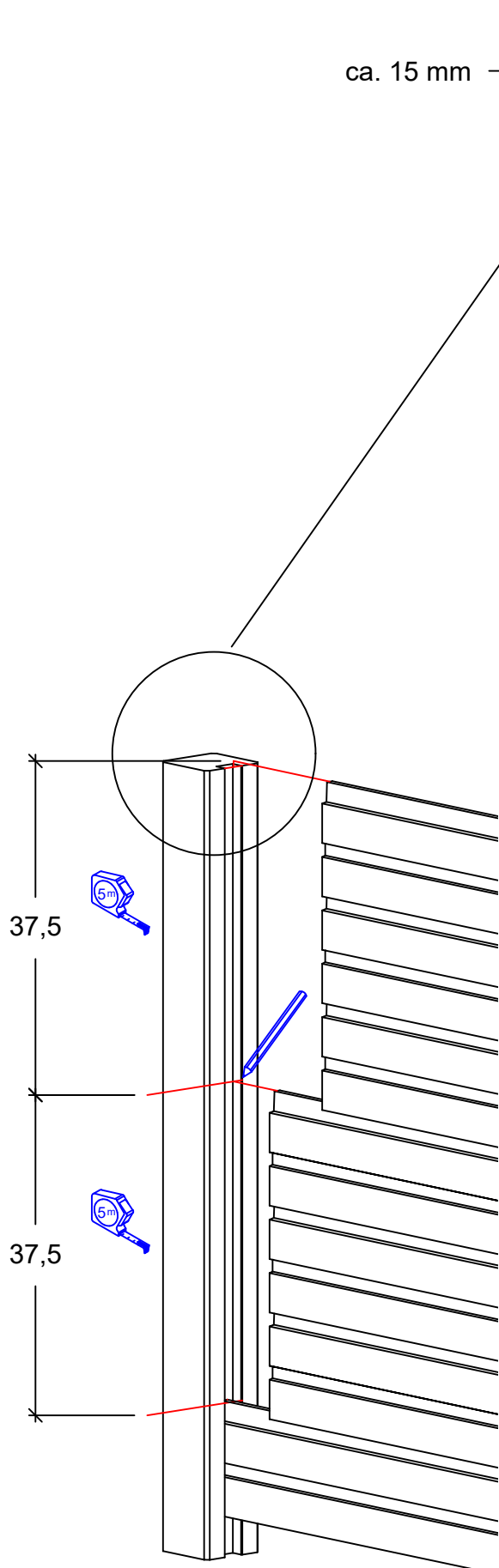

ca. 15 mm

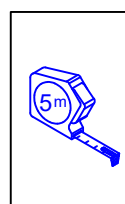
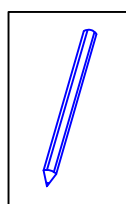
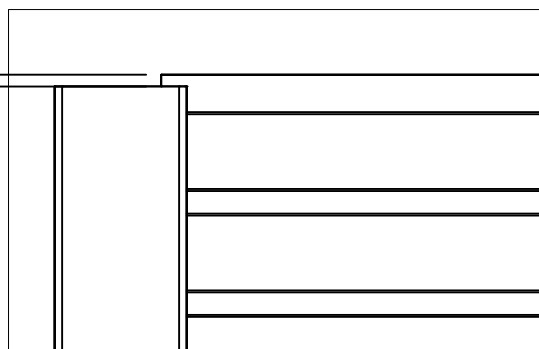

Nederste planke fastskrues.

Mål og markør på stolpen, placering af de næste 3 planker. (37,5 cm).

Fortsæt monteringen af de øvrige brædder, dog kun med 3 stk. af gangen, så der er mulighed for justering/jævn fordeling inden de fastskrues.

Se også billedserie på side 3 - 7 og 8.

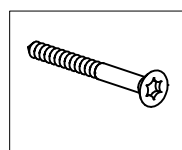

17773-1 / 15

10 planker

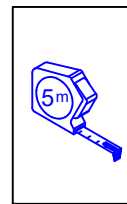
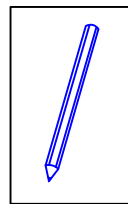
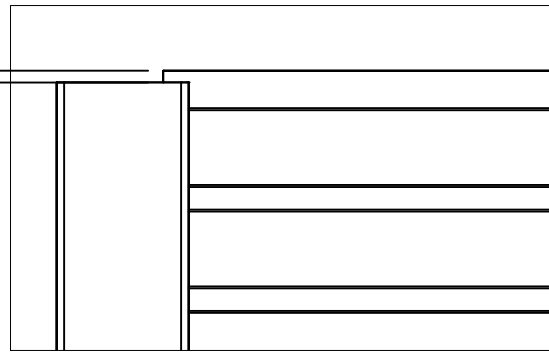
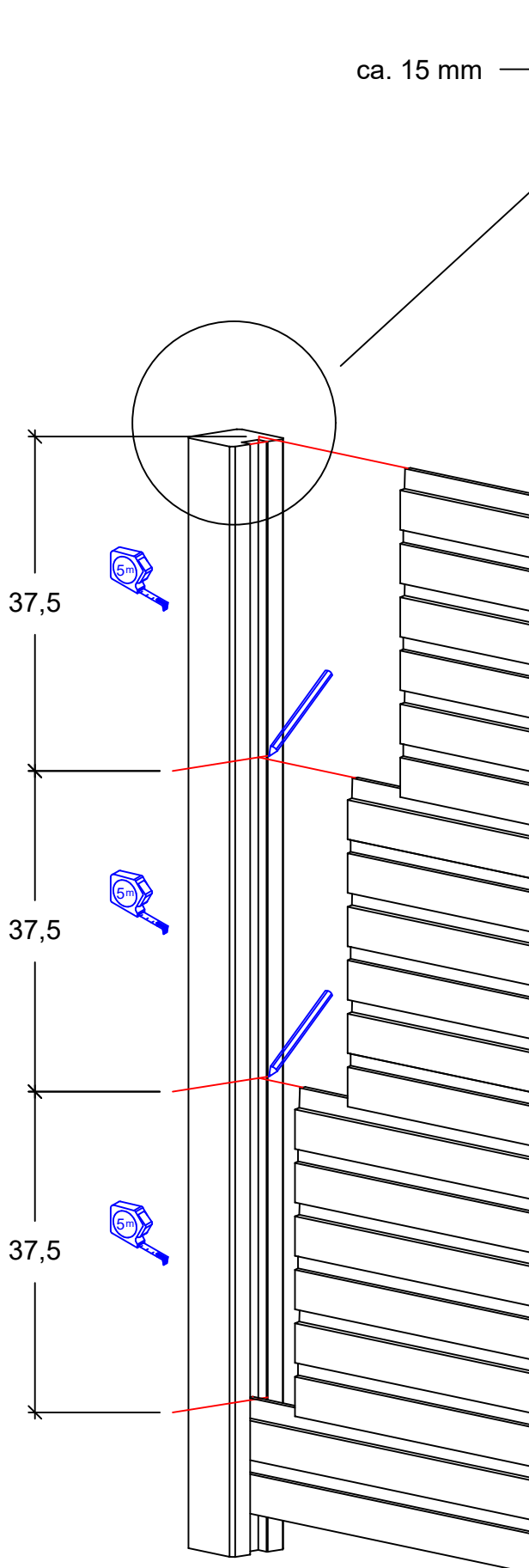

Nederste planke fastskrues.

Mål og markør på stolpen, placering af de næste 3 planker. (37,5 cm).

Fortsæt monteringen af de øvrige brædder, dog kun med 3 stk. af gangen, så der er mulighed for justering/jævn fordeling inden de fastskrues.

Se også billedserie på side 3 - 7 og 8.

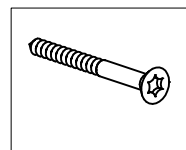

17774-1 / 15

13 planker

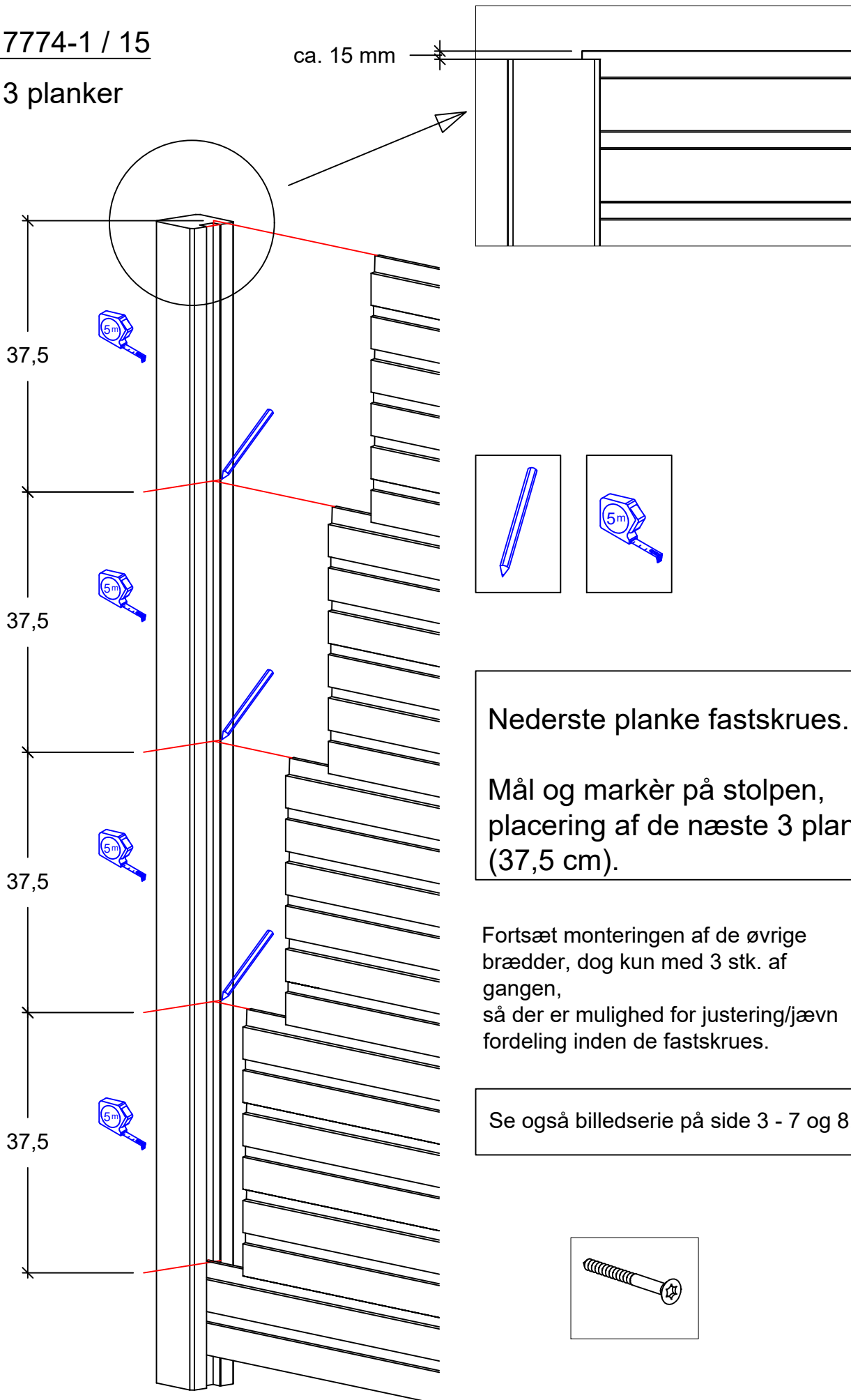



Spor passer ikke ud for hinanden.

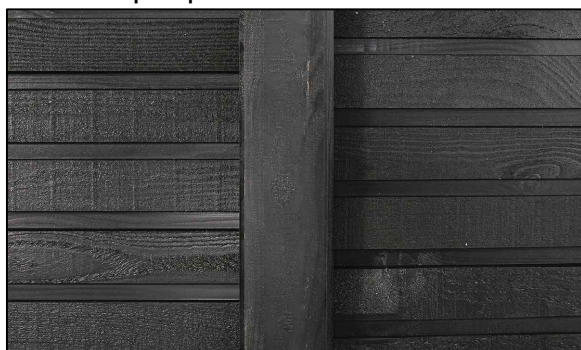

Spor passer ud for hinanden.

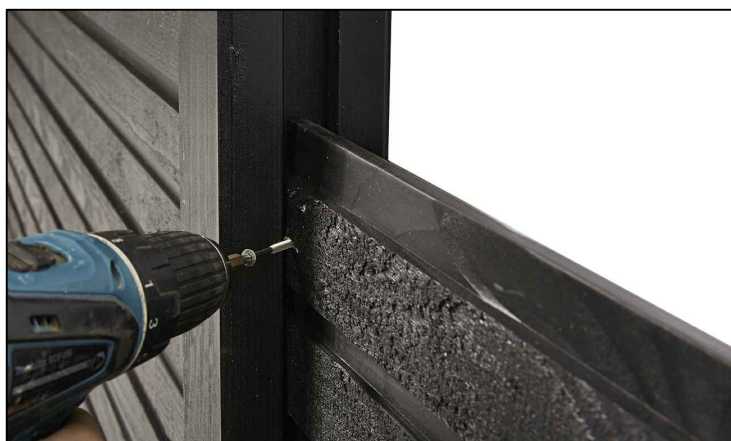
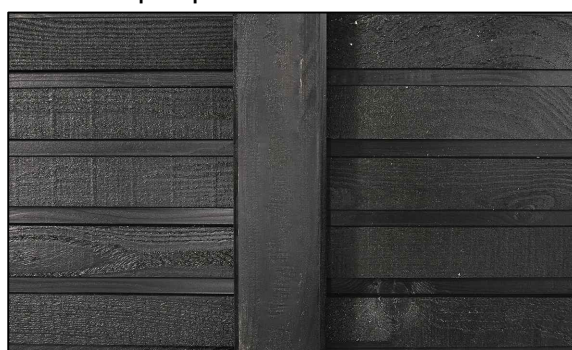

Fastgørelse af brædder.
1 skrue i hver side.

(Bortset fra bund og top bræt, de fastgøres med 2 skruer i hver side).



Stolpen afsaves så den passer med
højden på hegns brædder.
Fer på øverste bræt skal kunne
passe op i not på toplisten.



Toplisten fastgøres med 2 skruer midt på stolpen, hvis hegnet er fortløbende...!

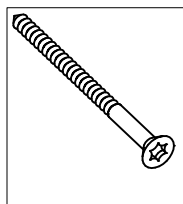

Toplisten fastgøres med 2 skruer i stolpe og med lidt "udhæng" hvis man ønsker det, ellers afsaves så den flugter med stolpe...!

Brædder og stolper er fra fabrikken Trykimprægneret -1 og (-15 er derefter grundmalet sort). Pga. fugtindholdet i træet på produktionstidspunktet vil imprægneringen primært blive optaget i overfladen.

For at forlænge holdbarheden, er det derfor hensigtsmæssigt at efterbehandle produkterne med træpleje.

Venligst bemærk:

Egenskaber og karakteristika, der er typiske for træ som:

Revnedannelse i overfladen. Kan fyldes med en egnet spartelmasse.

- Harpikslommer/harpiksudtræk
- Knasthuller er også en naturlig bestanddel i træ.
- Træ er et naturprodukt

Ovennævnte reducerer ikke træets kvalitet og berettiger derfor ikke til reklamation.

Spørg din lokale farveekspert om efterbehandling.

Gem denne vejledning til senere brug.

Se www.plus.dk for yderligere information vedr. vedligehold.