

RGB

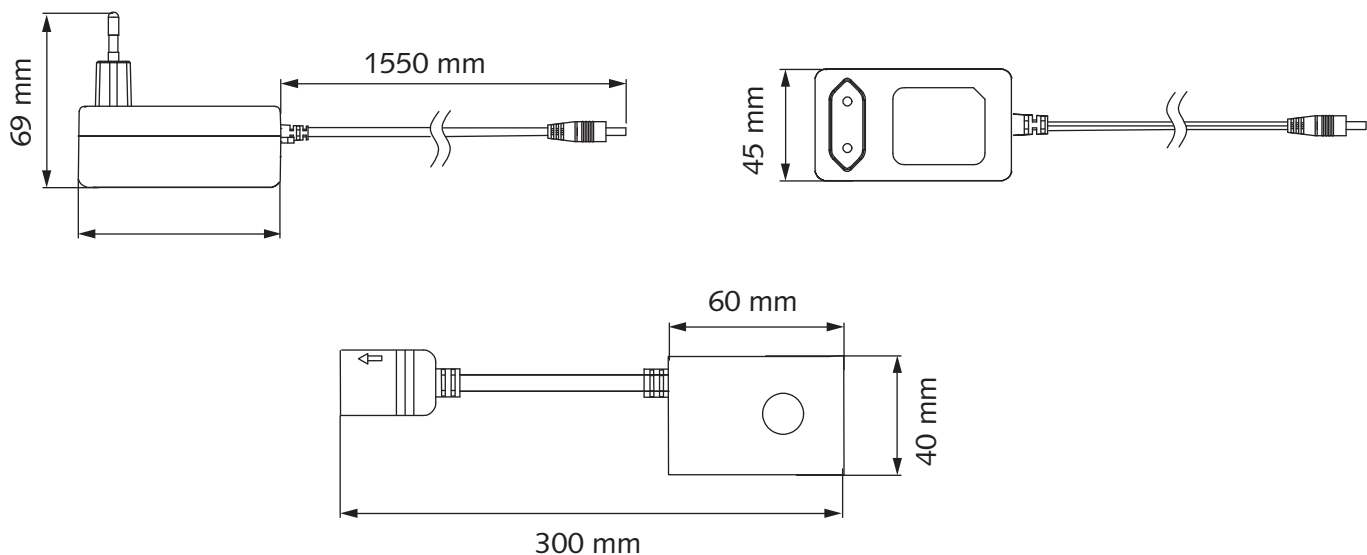

99 752 43: 5 m

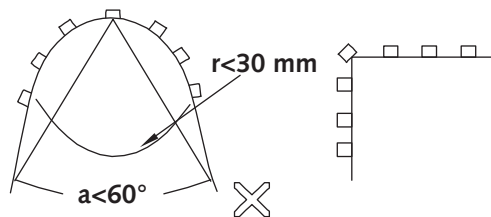
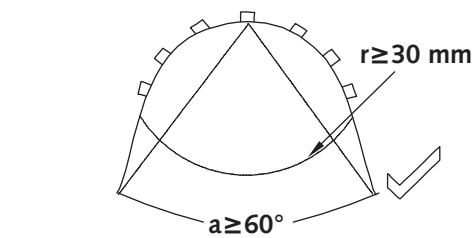
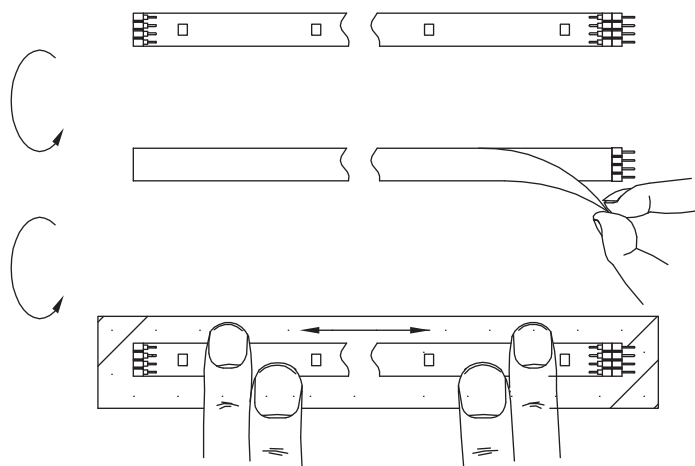
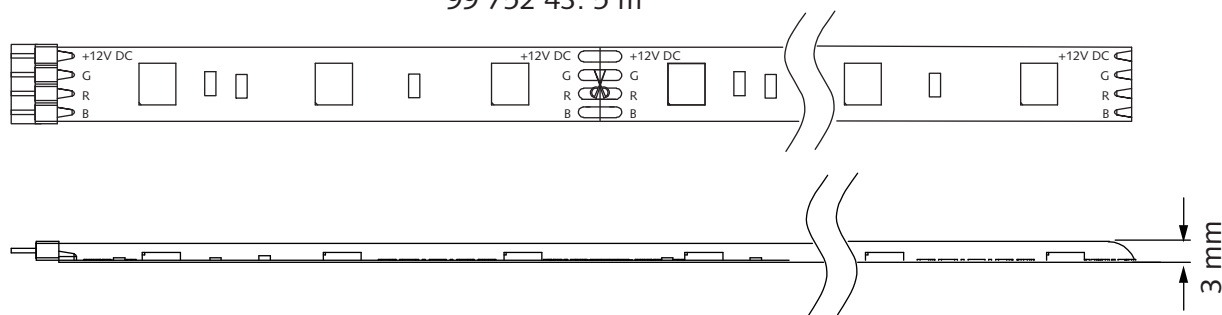

\* Driver: IP20  
\* LED strip: IP44



**MALMBERGS**

## BRUKSANVISNING

## Smart Home LED-strip

Art.nr: 99 752 43

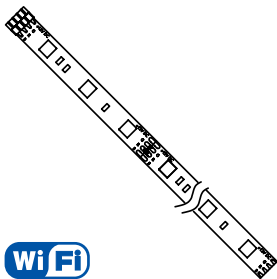

RoHS



MALMBERGS

Malmbergs Elektriska AB  
Box 144, 692 23 Kumla, SVERIGE

www.malmbergs.com



iOS APP/Android APP

- Skanna QR-koden för att ladda ner MALMBERGS-appen. Du kan också ange sökordet "malmbergs" på App Store eller Google Play för att ladda ner appen.



- Registrera ditt konto med ditt mobilnummer eller e-postadress, vänta några minuter för verifikationskod (som du får via sms eller e-post). Skriv in koden i det angivna fältet och ange sedan lösenord och "Create Family". Om du redan har ett konto, logga in direkt med ditt mobilnummer eller e-postadress samt lösenord för att öppna appen.

2

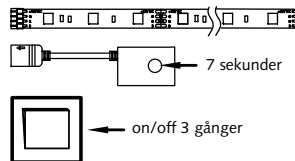

- Antingen tryck och håll ner återställningsknappen på WIFI kontrollen i 7 sek eller tryck on/off 3 gånger på strömbrytaren (on-off-on-off-on, ON tid <1s, OFF tid 3-4s). LED-strippen kommer att blinka snabbt 2 gånger i 5 och är nu i konfigureringsläge.

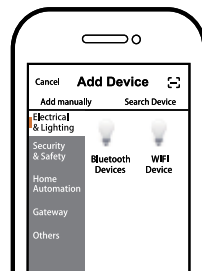

- Tryck på "+" (lägg till enhet) för att välja lämplig produktkategori och följ instruktionerna på skärmen för konfiguration.

3



- När konfigurationen är klar, kommer enheten att visas i appen.

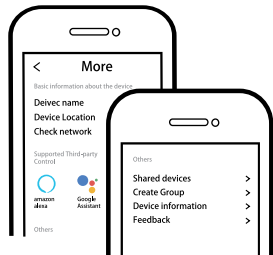

- Anslut till Amazon Alexa eller Google Assistant för röststyrning, eller dela enheten med din familj och vänner.

4

## ⚠ OBS:

Innehåll, ikoner och symboler som visas i mobilappen kan komma att ändras utan föregående varning p.g.a. kontinuerlig uppgradering och förbättring.

## TEKNISKA SPECIFIKATIONER

Typ av produkt	WIFI Smart LED-strip
Nätspänning	220-240V AC
Effekt	16W
Driftsfrekvens	2.412GHz - 2.484GHz WIFI
Sändningseffekt	< 20dBm
Drifttemperatur	Ta: -10°C - +40°C
Mått (LxBxH)	5000x10x3 mm
Kapslingsklass	IP20
<b>EMC-standard (EMC)</b>	
EN55015: 2013-A1:2015, EN61547: 2009, EN61000-3-2: 2014	
<b>Elsäkerhet (LVD)</b>	
EN 60598-1: 2015, EN 60598-2-20: 2015, IEC62778: 2014, EN 62493: 2010, EN62493: 2015	
<b>RoHS-standard (RoHS)</b>	
2011/65/EU, (EU) 2015/863	
<b>Radio (RED)</b>	
EN 300 328 V2.1.1 (2016-11), EN 301489-1 V2.1.1 (2017-02), EN 301489-17 V3.1.1 (2017-02)	

5

## SYSTEMKRAV

- WIFI @ router
- iPhone, iPad (IOS 8.0 eller högre)
- Android 4.4 eller högre

## DECLARATION OF CONFORMITY

Härmed försäkras vi att produkten uppfyller bestämmelserna för CE-märkningen i enlighet med EU-direktiven (LV-direktiv 2014/35/EU, EMC-direktiv 2014/30/EU, RE-direktiv 2014/53/EU, RoHS-direktiv 2011/65/EU) enligt beskrivningen i denna manual.

För och på uppdrag av:

*Anders Folke*

Malmbergs Elektriska AB (publ).  
Anders Folke / Produktchef  
Datum: 25 Feb., 2019

6

## INSTRUCTION MANUAL

Smart Home LED Strip

Art.No.: 99 752 43

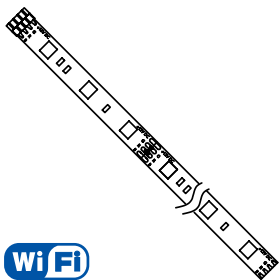

RoHS CE

**MALMBERGS**Malmbergs Elektriska AB  
PO Box 144, SE-692 23 Kumla, SWEDEN

www.malmbergs.com

## APP USER MANUAL



iOS APP/Android APP

- 1 Scan the QR code to download the MALMBERGS App. You can also search the keyword "MALMBERGS" at App Store or Google Play to download the App.



- 2 Register your account with your mobile number or e-mail address, wait a few minutes for verification code (by text message or e-mail) and enter it where required to set a password, and "Create Family". If you already have an account, please log in directly with your mobile number or e-mail address and password to open the app.

2

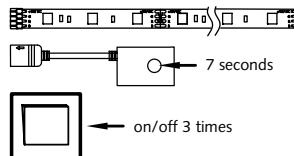

- 3 Either press and hold the "reset button" on the Wifi controller for 7 seconds or switch on/off 3 times (power on-off-on-off-on, on time<1s, off time 3-4s), then the LED strip will flash fast (twice 1 second) for pairing.

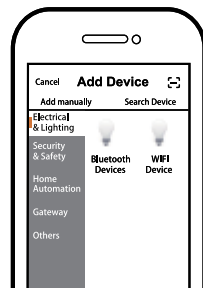

- 4 Click "+" (add device) to select the suitable product category and follow the on-screen instruction for pairing.

3



- 5 When pairing is done, the device will be shown in the App.

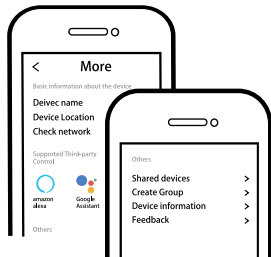

- 6 Connect to Amazon Alexa or Google Assistant for voice control, or share the devices with your families or friends.

4

**Note:**

Contents, icons and symbols shown in the mobile app may be subject to change without prior notice due to continuous upgrading and improvement.

## TECHNICAL SPECIFICATIONS

Product type	WiFi Smart LED Strip
Voltage	220-240V AC
Wattage	16W
Operation frequency	2.412GHz - 2.484GHz WiFi
Transmission power	< 20dBm
Operation temp.	Ta: -10°C - +40°C
Dims (LxWxH)	5000x10x3 mm
IP rating	IP20
<b>EMC Standard (EMC)</b>	
EN55015: 2013+A1:2015, EN61547: 2009, EN61000-3-2: 2014	
<b>Safety Standard (LVD)</b>	
EN 60598-1: 2015, EN 60598-2-20: 2015, IEC62778: 2014, EN 62493: 2010, EN62493: 2015	
<b>RoHS Standard (RoHS)</b>	
2011/65/EU, (EU) 2015/863	
<b>Radio Equipment (RED)</b>	
EN 300 328 V2.1.1 (2016-11), EN 301489-1 V2.1.1 (2017-02), EN 301489-17 V3.1.1 (2017-02).	

5

## SYSTEM REQUIREMENTS

- WiFi @ router
- iPhone, iPad (iOS 8.0 or higher)
- Android 4.4 or higher

## DECLARATION OF CONFORMITY

We hereby certify that the device satisfies the provisions for CE markings in accordance with the EU directives (LV Directive 2014/35/EU, EMC Directive 2014/30/EU, RE Directive 2014/53/EU, RoHS Directive 2011/65/EU) as described in this manual.

For and on behalf of:

Malmbergs Elektriska AB, Sweden.  
Mr. Anders Folke / Product Manager  
Date: 25 Feb., 2019

6

## KÄYTTÖOHJE

Smart Home LED-nauha

Art.No.: 99 752 43

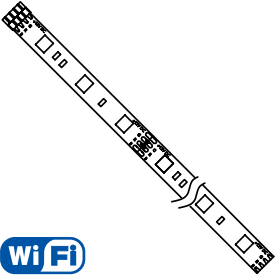

RoHS CE



**MALMBERGS**

Malmberg Elektro  
Oy Juhaniantie 1, 01740 Vantaa, SUOMI

www.malmbergs.com

## SOVELLUKSEN OHJE



iOS APP/Android APP

- Skannaa ylläoleva QR-koodi ladatakseeni MALMBERGS- sovelluksen. Voit myös hakea sovellusta sovelluskaupastasi (App Store tai Google Play) hakusanalla "MALMBERGS".



- Rekisteröidy sovellukseen puhelinnumerosi tai sähköpostiosoitteellasi ja odota muutama minuutti vahvistuskoodia (tekstiviestillä tai sähköpostilla). Syötä vahvistuskoodi, luo salasana ja valitse "Create Family". Jos sinulla on jo käyttäjätili, kirjautu sisään 2.4GHz WIFI-verkossa puhelinnumerosi tai sähköpostiosoitteellasi sekä salasaneläsi avatakseen sovelluksen.

2

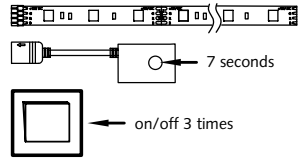

- Paina joko WIFI-ohjaimen nollauspainiketta seitsemän sekunnin ajan, tai kytke valokatkaisijasta nopeasti päälle/pois kolme kertaa kunnes LED-nauha alkaa vilkkumaan merkinä valmiudetta parittamiseen.

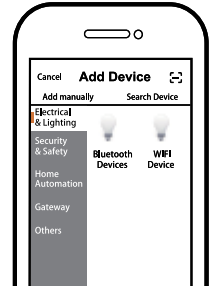

- Paina "+" (add device) valitaksesi ohjattavan laitteen tyyppin ja seuraa näytön ohjeita.

3



- Kun paritus on valmis, laite näkyy sovelluksessa.

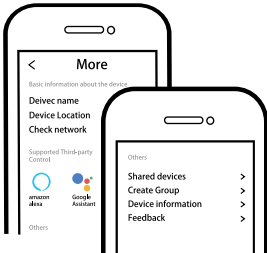

- Yhdistä Amazon Alexaan tai Google Assistantin ääniohjausta tai laitteen perheelle/ystävälle jakamista varten.

4



**Huom:**  
Ohjeen sisältö, ikonit ja symbolit sovelluksessa voivat muuttua ilman erillistä ilmoitusta päivityksien ja tuotteen kehityksen myötä.

## TEKNISET TIEDOT

Tuotteen tyyppi	Smart Home LED-nauha
Nimellisjännite	220-240V AC
Teho	16W
Käyttötaajuus	2.412GHz - 2.484GHz WIFI
Lähetysteho	< 20dBm
Käyttölämpötila	Ta: -10°C - +40°C
Mitat (PxLxK)	5000x10x3 mm
Suojausluokka	IP20
EMC standardi (EMC)	EN55015: 2013+A1:2015, EN61547: 2009, EN61000-3-2: 2014
Suojausstandardi (LVD)	EN 60598-1: 2015, EN 60598-2-20: 2015, IEC62778: 2014, EN 62493: 2010, EN62493: 2015
RoHS standardi (RoHS)	2011/65/EU, (EU) 2015/863
Radiostandardi (RED)	EN 300 328 V2.1.1 (2016-11), EN 301489-1 V2.1.1 (2017-02), EN 301489-17 V3.1.1 (2017-02).

5

## JÄRJESTELMÄVAATIMUKSET

- WIFI @ reititin
- iPhone, iPad (iOS 8.0 tai uudempi)
- Android 4.4 tai uudempi

## VAATIMUKSEN MUKAISUUSILMOITUS

Täten vakuutamme että tuote täyttää CE vaatimukset noudattaen tässä ohjeessa mainittuja EU-direktiivejä (LV Directive 2014/35/EU, EMC Directive 2014/30/EU, RE Directive 2014/53/EU, RoHS Directive 2011/65/EU).

Yhtiön puolesta ja nimissä:

*Anders Folke*

Malmbergs Elektriska AB, Sweden.  
Mr. Anders Folke / Product Manager  
Date: 25 Feb., 2019

6

## BRUKSANVINSNING

Smart Home LED-strip

Art.nr.: 99 752 43

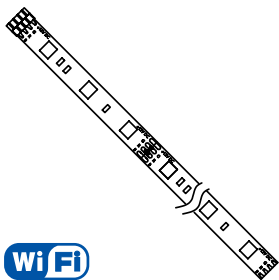

Malmergs Elektriske AS  
Kleaverveien 6, 1540 Vestby, NORGE

www.malmergs.com

## BRUKSANVINSNING FOR APP



IOS APP/Android APP

- Skann QR-koden for å laste ned MALMBERGS-appen. Du kan også skrive inn søkeordet "malmergs" på App Store eller Google Play for å laste ned appen.



- Registrer din konto med ditt mobilnummer eller e-postadresse, vent noen minutter for verifiseringskode (som du får via sms eller e-post). Skriv inn koden i det angitte feltet og skriv deretter passordet og "Create Family". Om du allerede har en konto, logg på direkte med ditt mobilnummer eller e-postadresse samt passord for å åpne appen.

2

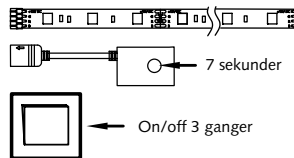

- Enten trykk og hold nede «reset-knappen» på WIFI kontrollen i 7 sekunder eller on/off 3 ganger (on-off-on, ON tid <1s, OFF tid 3-4s). LED-strip vil blinke hurtig to ganger i 1s og er nå klar for sammenkobling.

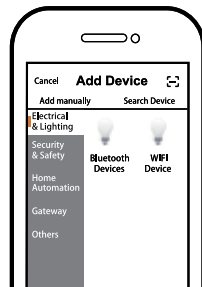

- Trykk på "+" (legg til enhet) for å velge passende produktkategori og følg instruksene på skjermen for konfigurasjon.

3



- Når konfigurasjonen er fullført, vil enheten vises i appen.

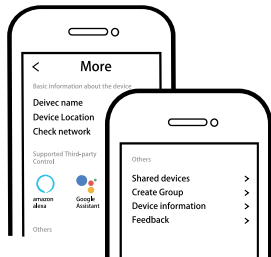

- Koble til Amazon Alexa eller Google Assistant for stemmestyring, eller del enheten med din familie og venner.

4

**OBS:**

Innhold, ikoner og symboler som vises i mobilappen kan endres uten foregående varsel grunnet kontinuerlig oppgradering og forbedring.

## TEKNISKE SPESIFIKASJONER

Type produkt	WIFI Smart LED-strip
Nettspenning	220-240V AC
Effekt	16W
Driftsfrekvens	2.412GHz - 2.484GHz WIFI
Sendingsseffekt	< 20dBm
Driftstemperatur	Ta: -10°C - +40°C
Mål (LxBxH)	5000x10x3 mm
Kapslingsklasse	IP20
EMC standardi (EMC)	EN55015: 2013+A1:2015, EN61547: 2009, EN61000-3-2: 2014
Elsikkerhet (LVD)	EN 60598-1: 2015, EN 60598-2-20: 2015, IEC62778: 2014, EN 62493: 2010, EN62493: 2015
RoHS-standard (RoHS)	2011/65/EU, (EU) 2015/863
Radio (RED)	EN 300 328 V2.1.1 (2016-11), EN 301489-1 V2.1.1 (2017-02), EN 301489-17 V3.1.1 (2017-02).

## SYSTEMKRAV

- WIFI @ router
- iPhone, iPad (iOS 8.0 eller høyere)
- Android 4.4 eller høyere

## DECLARATION OF CONFORMITY

Vi bekrefter hermed at produktet oppfyller bestemmelsene for CE-merkingen i samsvar med EU-direktiver (LV-direktiv 2014/35/ EU, EMC-direktiv 2014/30/EU, RE-direktiv 2014/53/EU, RoHS-direktiv 2011/65/EU) som beskrevet i denne manual.

For og på vegne av:

*Anders Folke*

Malmergs Elektriske AB  
(publ). Anders Folke / Produksjef-  
Date: 25 Feb., 2019

6

5

Vejledning

Smart Home LED-strip

Art.nr.: 99 752 43

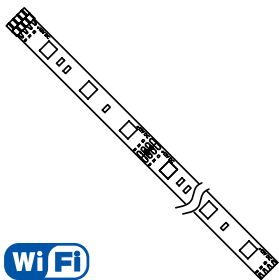

RoHS



MALMBERGS

Malmbergs Elektriske A/S  
 Generatorvej 14, 2860 Søborg, Danmark

[www.malmbergs.com](http://www.malmbergs.com)

## BRUGERMANUAL FOR APP



iOS APP/Android APP

- 1 Scan QR-koden for at downloade MALMBEGRS-appen. Du kan også anvende søgeordet "malmbergs" på App Store eller Google Play for at downloade appen.



- 2 Registrer din konto med dit mobilnummer eller email adresse, vent nogle minutter på verifikationskode (som du får via sms eller e-post). Skriv koden i det angivne felt og indtast herefter password og "create Family". Hvis du allerede har en konto, så login direkte med dit mobilnummer eller email adresse samt password for at åbne appen.

2

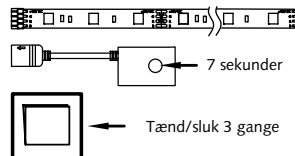

- 3 Enten tryk og hold "reset knappen" nede på WIFI kontrollere i 7 sekunder eller tænd/sluk-afbryderen 3 gange. LED stripen blinker hurtigt når den er klar til at blive parret

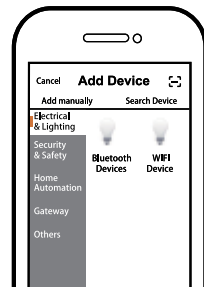

- 4 Tryk på "+" (tilføj enhed) for, at vælge egnet produktkategori og følg instruktionerne på skærmen for konfiguration.

3



- 5 Når konfigurationen er klar, så vises enheden i app'en

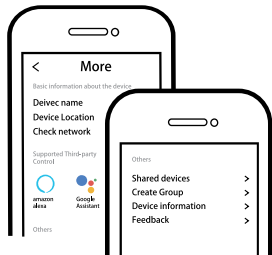

- 6 Tilslut Amazon Alexa eller Google Assistant for stemmestyring, eller del enheden med din familie og venner.

4

**⚠ OBS:**  
 Indhold, ikoner og symboler vises i mobilappen kan ændres uden tidligere advarsel på grund af kontinuerlig opgradering og forbedringer.

## TEKNISKE DATA

Type	WiFi Smart LED-strip
Mærkespænding	220-240V AC
Effekt	16W
Driftsfrekvens	2.412GHz - 2.484GHz WiFi
Sendeeffekt	< 20dBm
Driftstemperatur	Ta: -10°C - +40°C
Mål (LxBxH)	5000x10x3 mm
Kapslingsklasse	IP20
<b>EMC direktiv (EMC)</b>	
EN55015: 2013+A1:2015, EN61547: 2009, EN61000-3-2: 2014	
<b>LVD direktiv (LVD)</b>	
EN 60598-1: 2015, EN 60598-2-20: 2015, IEC62778: 2014, EN 62493: 2010, EN62493: 2015	
<b>RoHS direktiv (RoHS)</b>	
2011/65/EU, (EU) 2015/863	
<b>ETSI standard (RED)</b>	
EN 300 328 V2.1.1 (2016-11), EN 301489-1 V2.1.1 (2017-02), EN 301489-17 V3.1.1 (2017-02).	

## SYSTEMKRAV

- WiFi @ router
- iPhone, iPad (iOS 8.0 eller højere)
- Android 4.4 eller højere

## OVERENSSTEMMELSESEKTLÆRING

Hermed sikre vi, at produktet opfylder bestemmelserne for CE-mærkningen i overensstemmelse med EU-direktivet (LV-direktiv 2014/35/EU, EMC-direktiv 2014/30/EU, RE-direktiv 2014/53/EU, RoHS-direktiv 2011/65/EU som er beskrevet i denne manual.

For og på vegne af:

*Anders Folke*

Malmbergs Elektriske AB  
 (publ). Anders Folke / Produktsjef-  
 Dato: 25 Februar 2019.

6