

# Elegance Rigid 55

LUXURY VINYL TILES

## A TOOLS FOR THE INSTALLATION OF ELEGANCE RIGID 55

- Knife with straight blade
- Protective gloves
- White-headed rubber mallet
- Folding rule/measuring tape
- Pencil/T-square
- Spacers
- Jigsaw
- Scriber

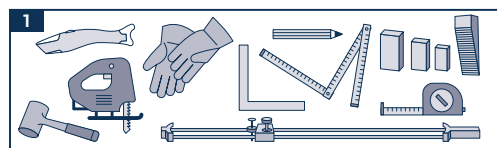

## B PREPARATION AND IMPORTANT INFORMATION PRIOR TO INSTALLATION

### B.1 EXAMINATION OF THE GOODS

Check the quality of the goods supplied before proceeding with the preparation work. Claims cannot be made on goods that have been cut to size or laid. The installation must be done using the same production batch in order to guarantee the uniformity of color and design. For wood design, we recommend to use planks of minimum 3 different boxes and to mix them not to have the same design next to each other.

### B.2 ACCLIMATISATION

Elegance Rigid 55 should be acclimatized for at least 24 hours in the rooms where it is to be installed according to the conditions detailed below.

### B.3 ROOM TEMPERATURE CONDITIONS

Elegance Rigid 55 should be installed at room temperature, between 15°C and 25°C. The temperature of the subfloor on which the product is to be installed must not be less than 10°C.

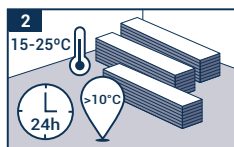

### B.4 SUBFLOOR CONDITION

Prepare the surface according to the standards in force in your country. The surface must be level, firm and not exposed to rising humidity. See permitted subfloors mentioned below. The maximum flatness tolerance is 3 mm under 2 m metal ruler. Textile and needle felt floor coverings must be removed. In principle, it is recommended that all floorcoverings are removed.

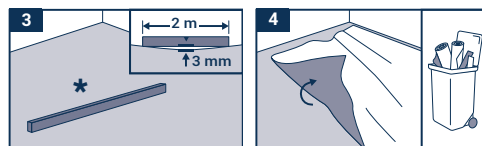

We advise not proceeding with the installation of Elegance Rigid 55 in the event of:

- Significant uneven areas (in excess of standards of flatness applied in the countries concerned).
- Cracks in the subfloor.
- Subfloor insufficiently dry.
- Surface insufficiently firm, too porous or too rough.
- Surface contaminated, e.g. by oil, wax, varnish or paint residue.
- Difference in level between the subfloor and other structural elements.
- Unsuitable subfloor temperature (below 10°C).
- Room temperatures lower than 15°C or higher than 25°C.
- No heating protocol in case of underfloor heating system.
- Underfloor heating systems which maximum temperature exceeds 28°C.

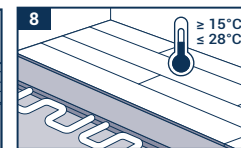
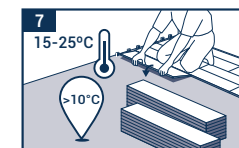
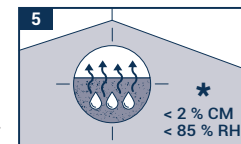

### PERMITTED SUBFLOOR

- Fixed wooden floor (when respecting local regulations).
- Even stone floors, marble, ashlar
- Ceramic tiles (seam requirements: ≤ 6 mm wide/≤ 3 mm deep).
- Compact PVC and linoleum coverings.
- Uneven floor screeds: new or reworked.
- The warranty of the product is invalid when unapproved subfloors are used.

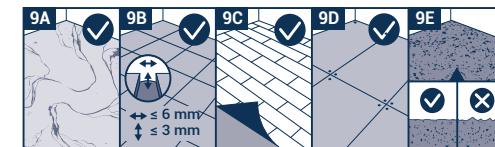

## C-INSTALLATION

### C.1 INSTALLATION DIRECTION

Always start the installation from left to right. In a room, install the panels so that the planks are in the direction of the light. In long, narrow rooms, such as corridors, Elegance Rigid 55 can be installed in the direction of the room.

## Elegance Rigid 55

### C.2 INSTALLATION

Using a suitable spacer, create an expansion gap at least 6 mm wide along the entire periphery. TIP: Use flooring cutoffs as spacers. Also maintain a gap of 6 mm from all fixtures in the room, such as pipes, door frames etc. In principle, this expansion gap must not be filled with silicone, electric cables or other items.

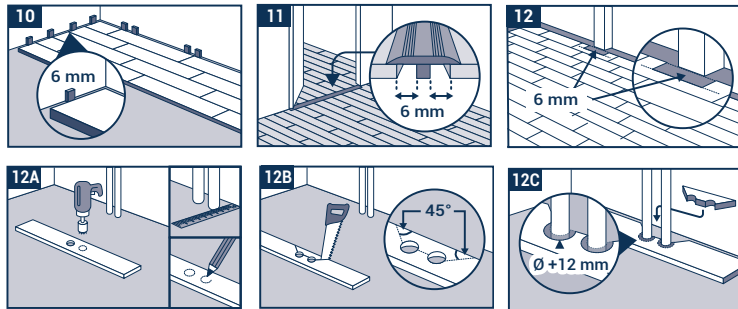

### C.3 THE USE OF SILICONE IS PERMITTED IN THE FOLLOWING EXCEPTIONAL CASES:

Damp rooms: edge joints in damp rooms of max. 12 m<sup>2</sup>, e.g. bathrooms or kitchens, may be made with soft silicone in order to avoid any infiltration of water through the expansion gap and onto the installed surface. For all larger areas in damp rooms, we recommend starting by applying insulating tape to the area of the gap before filling it with a quantity of silicone and/or using a skirting board with a sealing lip.

### C.4 INSTALLATION

Install the first panel with the tongue side facing the wall, then install all the other panels in the same from left to right. Make sure that the ends are placed one on top of the other so that the grooves and the tongues correspond exactly and lock them by tapping lightly with a white-headed rubber mallet. To install the next row, place the left-over panel of at least 30 cm in length into the longitudinal groove of the row already installed at an angle of approximately 30° and lower it into the previous row using slight pressure. Take the next panel, place it also at an angle of approximately 30° in the longitudinal direction on the panel of the first row already installed, align it as closely as possible with the end of the panel previously installed and lock it as described above. This method is then used to install all of the other rows. Make sure that the end joints are offset by at least 30 cm in the individual rows in order to achieve the best installation. To install the last row, the distance between the wall and the row installed is measured and transferred to the panel. The last row installed should be as close to half a panel's width as possible. Remember to let at least 6 mm wide expansion gap. If the wall is not straight, the first row needs to be cut, following the wall profile with a scribe, to always keep the min. 6 mm expansion gap around the room.

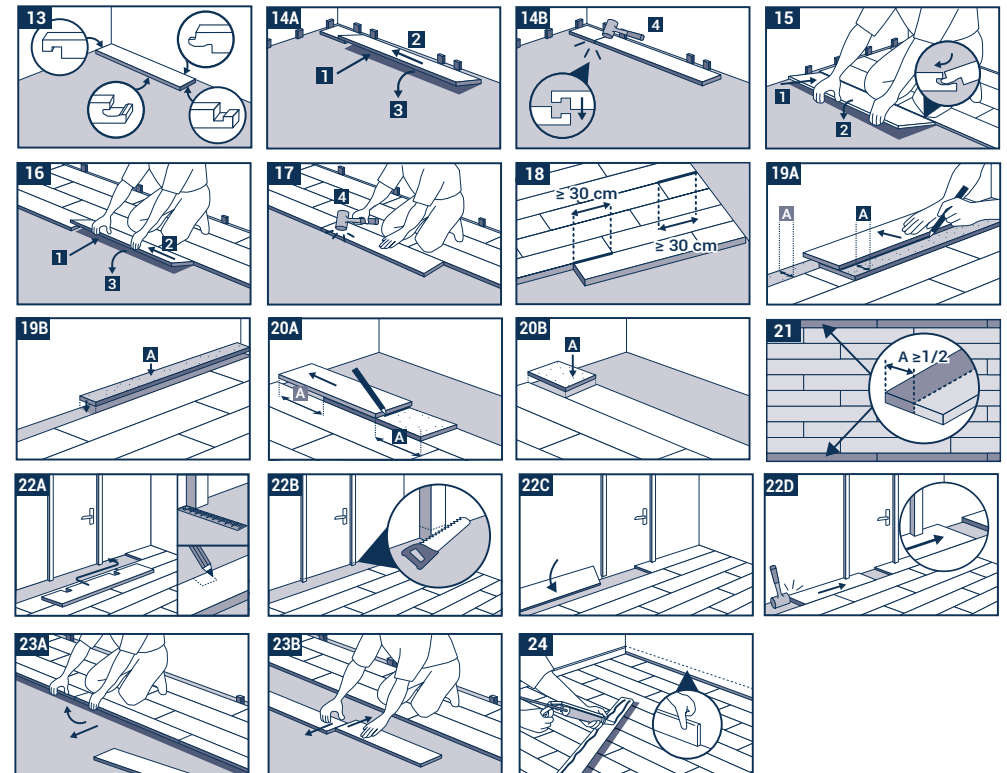

### C.5 EXPANSION PROFILES WITHIN THE AREA

Expansion gap should be 1 mm per linear meter installed with a minimum of 6 mm and a maximum of 12 mm. Rooms with an uninterrupted area of 225 m<sup>2</sup> may benefit from a joint-free installation taking into account twice the expansion gap (12 mm). Do not exceed a length of 15 m. Expansion profiles have to be used in rooms that are extremely long and narrow. Room areas interrupted by vertical elements (columns, walls, door frames, etc.) must be divided using expansion gap of at least 6 mm at the same level as these elements. When installing skirting boards, transition profiles or end profiles, the skirting boards or profiles must never be fixed to the floor covering. Contact your Tarkett representative if you would like more information on this.

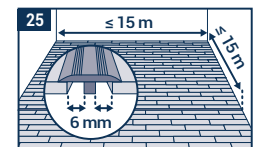

## Elegance Rigid 55

### IMPORTANT INFORMATION ON COMPLETING THE INSTALLATION

- Remove all of the spacers.
- Before the final installation of skirting boards or profiles, the offcuts and any other debris should be removed out of dilatation gaps.
- Elegance Rigid 55 must never be blocked or fixed to the subfloor, underlay, furniture or other fixtures.
- Place a walk-off mat at outside entrances to reduce the amount of dirt brought into your home. Do not use mats with a latex or rubber backing since these backings can cause permanent discoloration.
- Please use sliders suitable for hard floors if mobile furniture is used. Never drag heavy items or furniture over the floor, but lift them up.
- Please provide office chairs and other wheeled equipment with W type castors. For higher protection, desk mat can be installed under castor chairs and rolling furnitures.
- We recommend the application of a protective layer of TarkoProtect before the finished floor is used.

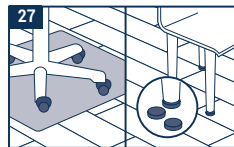
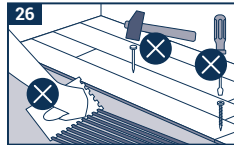

### PARTICULARITIES AND EXCEPTIONAL SITUATIONS

- Before installation, the product should be acclimatized at room temperature (between 15°C and 25°C) for at least 24 hours. This is especially important in unheated rooms, conservatories or adjacent to patio doors.
- At all times after installation, extreme variations in room temperature should be avoided and temperature measured above the floor should not go below 10°C or over 50°C.
- When installing Elegance Rigid 55 in areas that are exposed to significant temperature fluctuations the expansion joint may be doubled to 12 mm on the entire periphery and from all fixtures in the room.
- Dyed rubber-based wheels and castors (e.g. vehicle tyres, pneumatic tyres) may cause irreversible colour changes in cases of direct interaction and contact with vinyl surfaces.
- Heavy equipment (kitchen court, shelves,...) should be installed first and not placed over the Elegance Rigid 55, respecting the 6 mm expansion gap around the equipment or the furniture legs.

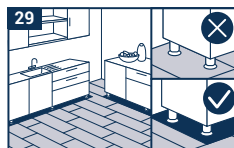
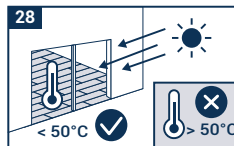

### CLEANING AND MAINTENANCE

Give the floor a final clean after installation. The floor can be maintained by sweeping, vacuuming or mopping. Use a brush and a pH-neutral detergent to remove stubborn dirt. All aggressive and staining substances must be removed from the surface immediately.

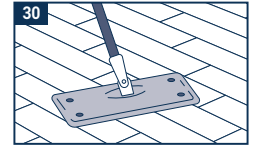

Note: Although Tarkett may list a selection of adhesive, levelling compound and surface damp-proof membrane manufacturers and types, we do not guarantee the products listed. The list of products and manufacturers is not guaranteed complete or current. Tarkett will accept no liability for any of these products failing to perform in conjunction with any of its products. It is the responsibility of the adhesive, levelling compound and surface damp-proof membrane manufacturer and flooring contractor to ensure the products being used are appropriate for use and applied in accordance with the manufacturers' recommendations. If any doubts or clarifications should be needed, please contact your local Tarkett representative for further information.