

MANUALE USO E MANUTENZIONE

USE AND MAINTENANCE MANUAL

MODE D'EMPLOI ET D'ENTRETIEN

MANUAL DE USO E MANUTENÇÃO

HANDLEIDING VOOR GEBRUIK EN ONDERHOUD

GEBRAUCHS-UND WARTUNGSHANDBUCH

INTRODUCTION

Dear Client,

Thank you for having purchased our product.

IMPORTANT:

Keep these use instructions with your product. Should the product be sold or transferred to other persons, ensure that it is accompanied by its instructions.

We ask that you carefully read these recommendations before installing and using the product. They have been drafted for your safety and those near you.

This manual gives indications to maintain the aesthetical and functional qualities of the oven unaltered.

NOTE:

The oven category is: II2H3+

Gas:

G30/31 28/37 mbar

G20 20 mbar

For technical data, see the technical data table (5).

You can also visit our website: [www.glemgas.com](http://www.glemgas.com) where you will find our latest news and much more useful and complementary information.

With the constant aim to improve our products, we reserve the right to amend their technical, functional or aesthetical features, parallel to the technical evolution.

Important:



Before starting the oven, carefully read this installation and use manual in order to know its functioning better.

SUMMARY

- 1. OVEN USE AND SAFETY WARNINGS ..... 16
- 2. INSTALLATION ..... 17
- 3. GAS CONNECTION ..... 18
- 4. ELECTRICAL CONNECTION ..... 18
- 5. TECHNICAL DATA ..... 19
- 6. INJECTOR REPLACEMENT ..... 19
- 7. BURNER AND THERMOSTAT REGULATIONS ..... 20
- 8. CONTROLS DESCRIPTION ..... 21
- 9. SWITCHING OVEN ON ..... 22
- 10. USE OF ELECEPIC/GAS GRILL ..... 22
- 11. OVEN MAINTENANCE AND CLEANING ..... 24
- 12. FIGURES ..... 75

**INSTRUCTIONS FOR THE INSTALLER**

They indicate the operations for the QUALIFIED ENGINEER who will have to carry out the installation, commissioning and testing of the appliance.

**INSTRUCTIONS FOR THE USER**

They indicate the operation, use and maintenance, the controls, accessories and the correct cleaning and maintenance operations.

**PRESENTATION****1. Oven use and safety warnings**

This appliance has been conceived for domestic and private use. It is exclusively intended for cooking food products. Therefore, any liability for uses different to those indicated is declined. None of the components of this oven are made with asbestos.

This appliance is exclusively intended for non-professional use. Do not use the appliance for commercial or industrial purposes or for any other purpose for which it was not conceived.

Do not amend and try to amend the technical features of this appliance, as this might present a danger for yourselves and for those near you.

- Attention: the accessible parts can heat up during use. Keep children away and ensure they do not play with the appliance.

Before using the oven for the first time, heat it up empty for about 15 min. Ensure the room is ventilated. You may smell a particular odour or notice a small emission of smoke. THIS IS NORMAL.

The appliance becomes hot during use. Do not touch the thermoelements inside the oven. Do not go near the hot upper elements with the hands when inserting or removing the pans or pan supports from the oven, use thermal kitchen gloves.

When cooking food, only use plates or pans resistant to high temperatures.

Never place aluminium foil directly on to the oven support surface, as the accumulated heat may cause the enamel to deteriorate.

Do not lay heavy objects on the oven door and ensure that children do not sit on it.

When cleaning the inside, ensure the oven is cold and, moreover, that it is switched off.

- This appliance must not be used by persons (including children) with reduced physical, sensory or mental capacities or by inexperienced or untrained persons, unless supervised by a responsible person or who have been suitably trained with regard to this appliance.

After having used the oven, ensure that all knobs are in the stop position.

Do not use the oven as storage for any object or to place inflammable objects.

Never use steam or high pressure equipment to clean the oven; this may cause problems to the electrical safety devices.

**1.1 Respecting the environment**

The packaging materials of this appliance can be recycled. Participate in recycling by contributing to safeguard the environment. Throw the different materials in the appropriate containers at your disposal in your town/city.

This appliance contains recyclable materials. They are marked with this logo indicating that the appliances used must not be disposed of with urban waste. They are therefore compliant with European Directive 2002/96/EC on waste of electrical and electronic equipment.

Contact your town/city or your dealer to know the collection points nearest to you.



We thank you for your collaboration in safeguarding the environment.

## INSTRUCTIONS FOR THE INSTALLER



## 2. Installation

This appliance complies with the EEC circular 82/499 relative to limitation of radio-electric interference.

The also oven complies with the D.L. n. 108 of 25/01/92 (Directive 89/109/CEE).

This appliance can be installed and operate only in rooms which are permanently ventilated according to UNI 7129/UNI 7131.

Installation must be carried out following the instructions in this manual on the part of qualified technical personnel. Maintenance and inspection must be carried out with the appliance disconnected electrically and the gas system cock closed.

Installation must comply with the following Standards in force:

- UNI 7129 (Installation to gas network for domestic use)
- UNI 7131 (Installation to LPG gas for domestic use)
- CEI electrical Standards

Installation is at the charge of the purchaser. Any requests made to the Manufacturer which depend on improper installation will not be covered by the warranty.

The qualified technician must leave you a declaration of conformity for the work carried out when he has done.

The same is to be considered liable for harm to persons or objects caused by connections that do not comply with Standards.

### 2.1 Oven positioning

The oven is pre-arranged for built-in purposes.

The sizes must respect the quota indicated in figures 1 and 2.

The upper/rear part of the cabinet must have an opening of at least 80-90 mm deep, as indicated in figure 1.

Tighten the 4 screws by firstly inserting them inside the bush and then inside the frame (figures 1 Rif. A/B).

For installations underneath the "top" surface, ensure that the rear/lower part of the cabinet has an opening similar to that shown in figure 1 (reference C).

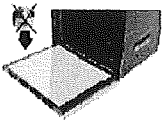

Do not use the door as lever to insert the oven inside the cabinet.  
Do not put pressure on the open door.

### 2.2 PLACE OF INSTALLATION

- ☞ The appliance must be installed and used in suitable areas and in any case it must be in conformity with laws in vigour. The installer must refer to laws in vigour concerning ventilation and evacuation of combustion products. It is reminded that the necessary area for combustion is 2m<sup>3</sup>/h per KW of power (gas) installed.

The area where the gas appliance is installed must have a natural flow of air, necessary for gas combustion (standards UNI-CIG 7129 and 7131).

The flow of air must come from one or more openings made on a free section of at least 100 cm<sup>2</sup> (A).

This opening must be constructed in a manner so that it is not obstructed internally or externally and must be near the floor, preferably on the opposite side of combustion product evacuation.

When it is not possible to make these openings, the air can come from an adjacent room, ventilated as required, as long as this room is not a bedroom, have a dangerous environment or sunk down (UNI-CIG 7129).

Combustion products exhaust

The gas cooking apparatus have to discharge the combustion products through hoods connected directly to chimney flues or directly to the outside, see figure.

Should it not be possible to install a hood, the use of an electric fan applied to an external wall or to the room window is necessary.

This electric fan must have a capacity which guarantees an air exchange in the kitchen at least 3-5 times its volume (UNI-CIG 7129).



Components illustrated in the figure

- A: Opening for air input  
 C: Hood for combustion products evacuation  
 E: Electric fan for combustion products evacuation

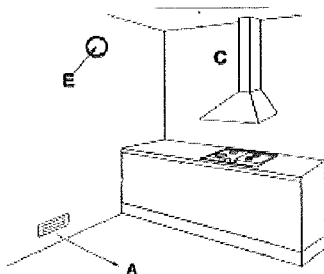

### 3. Gas connection

- ☞ Before installing, ensure that the local distribution conditions (gas nature and pressure) and the oven regulations are compatible. To do this, verify the data of the product label applied on the oven and on this booklet.

The gas connection must comply with Standards UNI-CIG 7129 and 7131. The oven must be connected to the gas plant using stiff metal tubes or stainless steel flexible tubes in the wall, compliant to Standard UNI-CIG 9891, with a maximum extension of 2 m.

When using flexible metal tubes, ensure that they do not come into contact with moving parts or are crushed.

Carry out the connection so as not to cause any kind of stress on the apparatus.

The gas input connection is threaded "G½".

For ISO R7 connections, it is not necessary to interpose the gasket.

For ISO R228 connections, it is necessary to interpose the head washer provided.

After the connecting operations, verify the connections sealing with a soapy solution.

### 4. Electrical connection



- Ensure that the voltage corresponds to that indicated in the plaque located on the oven door frame.  
 The cables for the connection to the mains must be protected from direct contact with the oven's metal casing.  
 The plaque must never be removed.



- Attention: the earth connection must be compliant with law.



if using a fixed connection, it is necessary to interpose a 4000V insulating category switch which assures the omnipolar disconnection of the built-in oven from the mains.

This switch must be installed inside the fixed plant according to the laws and standards in force.  
 Avoid using reductions or adaptors as they may cause overheating or burning.

## INSTRUCTIONS FOR THE INSTALLER



After installation, carry out a brief oven check, following the instructions reported further down.

In case the appliance does not function, disconnect it from the mains and contact the after-sales assistance centre nearest to you.

Do not attempt to repair the appliance.

The oven is provided with a cable without a plug.

The plug to be used must be the standardised type, being aware that:

- yellow - green = earth
- blue = neutral
- brown = phase

## ATTENTION:



The manufacturer declines any liability for damage suffered by persons and things, caused by the non compliance of the above prescriptions or deriving from the tampering of even a single part of the appliance and the use of non original spare parts.

## 5. Technical data

TYPE OF BURNER	TYPE OF GAS		PRESSURE (MBAR)	INJECTOR MARKING (1/100 mm)	GAS CONSUMPTION*	POWER	
						MAXIMUM	MINIMUM
OVEN (dm <sup>3</sup> 56/62)	LIQUID GAS	G30/31	28..30/37	79	189 g/h	2,600	1,000
	NATURAL GAS	G20	2J	119	248 g/h		
GRILL (dm <sup>3</sup> 56/62)	LIQUID GAS	G30/31	28..30/37	60	124 g/h	1,700	-
	NATURAL GAS	G20	2J	101	162 g/h		

## 6. Injector replacement

## 6.1 Oven Burner

Before replacing injectors, check that the oven is not connected electrically.

The operations are the following:

- Open the oven door completely;
- Extract the oven bed plate (Fig. A)
- Remove the burner, freeing it from the fastening screws. Using an adequate key, you can unscrew the injectors and replace them with others suitable for the type of gas listed on the table technical data.
- Put the bed plate back in place, taking care not to damage the glow plug wires and the thermocouple tubes, and tighten the screws.

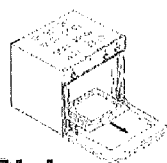
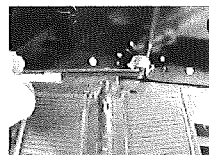

FIG. A





## 6.2 Grill Burner (if provided)

As regards the grill burner, proceed as follows:

- Open the oven door completely;
- Loosen the screws to remove the burner, unscrew the injectors using a suitable spanner and replace them with injectors appropriate for the type of gas shown in the Technical Data.
- When finished, put the grill burner back in place and tighten the screws.

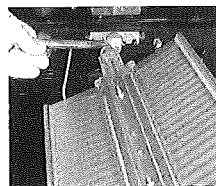

## 7. Thermostat minimum regulation

This operation is carried out when the oven is built-in the cabinet and after qualified personnel have carried out the electrical and gas connections.

The operation is necessary when passing from one type of gas to another (from natural gas G20 to liquid gas G30) in order to guarantee a minimum temperature close to 150°C.

The operations are the following (fig.3):

- Open the oven door (the burner inside the oven turns on only when the door is open)
- Remove the bed plate (see indications in paragraph 6 fig. A)
- Turn the oven on at the maximum temperature for 20 minutes
- When it is turned on, close the door
- Bring the thermostat knob back to the indicative temperature of 150°C
- Remove the knob "a"
- Insert a screwdriver in hole "b" in parallel with the thermostat leg and regulate the by-pass until a reduced but stable flame is obtained.

This operation must be carried out with the oven door closed.

- Act on the by-pass screw with a flat-bladed screwdriver. It is sufficient to unscrew the by-pass to regulate the minimum, passing from liquid gas to methane gas.
- To function with G30/31 gas (LPG), the regulation by-pass screw must be screwed all the way.



When the burner has been regulated, check that the flame remains at a minimum carrying out these operations:

- Rotate the knob from the min. position to the max. position 3 times,
- Open and close the oven door continuously for 4/5 times, neither too quickly nor too slowly
- If the flame goes out, regulate the by-pass once again (slightly increasing the minimum).

When these operations are over (injector replacement, air regulation and minimum regulation) turn the oven off and update the data label on the oven door frame, indicating the new type of gas in use.

### 7.1 Pre-use of oven and accessories

Before using the oven for the first time, remove all accessories and wash them with dishwashing soap. Dry them and then re-mount them in the oven.

Heat the oven at the maximum temperature for about 20 minutes in order to eliminate unpleasant odours caused by oils used by the manufacturer.

The oven has 5 guides for the positioning of the pots and pans at different heights.



INSTRUCTIONS FOR THE INSTALLER



PAN SUPPORT: Used as support for containers with food for cooking.

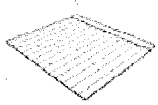

BAKING PAN: Used to cook food such as pizza, bread, etc.

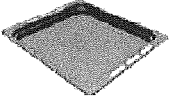

Not all accessories are present on certain models. It is possible to request the original accessories, in the model provided, through the authorised after-sales assistance centres.

INSTRUCTIONS FOR THE USER



8. Controls description

Act on the control devices placed on the oven panel to select the various functions with the knob.

8.1 Thermostat knob for electric/gas oven

Allows to choose the most suitable temperature for the food to be cooked. Turn the knob anticlockwise to select the temperature from 100°C to 250°C and to operate the oven burner. Turn the knob clockwise to operate the grill burner. Press the thermostat knob to ignite the burner.

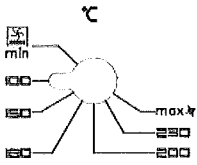

8.2 Thermostat knob for gas/gas oven

Allows to choose the most suitable temperature for the food to be cooked. Turn the knob anticlockwise to select the temperature from 100°C to 250°C and to operate the oven burner. Turn the knob clockwise to operate the grill burner. Press the thermostat knob to ignite the burner. The oven is always turned off bringing the knob index back to the panel index.

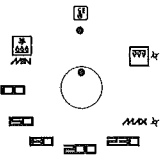

8.3 Mechanical minute counter

The minute counter can be regulated for a maximum period of one hour. The regulation knob must be turned clockwise until the 60 minute position, and then placed at the desired time, rotating it anticlockwise. When the pre-set time is over, an acoustic signal goes off, which stops automatically. The minute counter does not interrupt the oven functioning when the acoustic signals goes off.

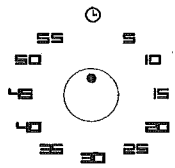





#### TURN ON SIGNALLER (GREEN) (IF PROVIDED)

- ☉ This light turns on when the oven is switched on for cooking. It remains on during the whole cooking period, turning off only when the oven is switched off.

#### SIGNALLER (ORANGE) FOR OVEN WITH ELECTRIC GRILL

- ☉ When the light turns on, it means that the oven is heating.
- When the light turns off while cooking it means that the oven has reached the pre-set temperature.
- Regular intermittence indicates that the temperature inside the oven is maintained constantly at the set

#### COOLING UNDER WAY INDICATOR FOR OVEN WITH GRILL GAS

- ☉ The light is on during cooling.
- Cooling may be extended as necessary after the oven is turned off.

## 9. Turning on the gas oven

The oven is turned on with the DOOR OPEN in the following way:

- > Press the thermostat knob lightly and rotate it anti-clockwise to the maximum position.
- > Press the knob all the way down to trigger the electric turning on and hold it for a few seconds until the safety device is activated.
- > Then position the knob on the desired temperature.

The oven burner is provided with a safety valve which blocks the gas flow in the following cases:

- The thermostat knob is rotated accidentally with gas flowing immediately to the oven burner.
- The burner flame goes out accidentally.
- There is no gas flow from the network.
- Avoid the burner from turning off during regulation of the oven from the maximum to the minimum temperature, the thermostat is provided with a stopping device. To turn the burner off from the minimum position, just press the knob lightly and rotate it until the knob index coincides with the fixed index on the front.

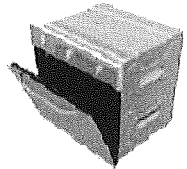

Turning on: the oven burner is turned on with the oven door open.

Should the door be only partially open, a safety device blocks the burners from turning on automatically

## 10. Use of the grill

### 10.1 Use of the electric grill selector

Position 0: Off

0

 Position 1: Oven light

 Position 2: Roasting rack

Turn the gas oven on and select the thermostat knob between 100°C and 250°C. This type of cooking is carried out with the oven door closed.

 Position 3: Grill + Roasting rack:

This type of cooking is particularly good for quick gilding of foods.

The selector in this position allows the automatic use of the roasting rack + grill.



#### Position 4: Grill:

This type of cooking is particularly good for quick grilling of foods.  
The selector in this position allows the automatic use of the grill.

### 10.2 Use of the gas grill selector



Position 0: Off



Position 1: Oven light



Position 2: Roasting jack

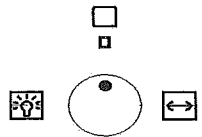

If during functioning of the electric grill the oven thermostat knob should turn by accident, a safety device will block the grill function.

To restore it, just rotate the oven knob until the knob index coincides with the fixed index on the panel (thermostat closing).

Before introducing food inside the oven, it is recommended to pre-heat it for at least 5 minutes.

Place the food to be grilled on the appropriate grill or on the pan, placing it on the highest guide (see paragraph 7.1) depending on the volume of the food to be grilled.

Place the dripping-pan on the step underneath the food in order to collect the grease.

Depending on the type of food to be cooked (meat, fish, chicken, etc.) it is necessary to turn the food on order to expose both sides to the rays of the heating elements.

Cooking with the grill must not exceed 30 minutes.



Note: The grill does not work when the over burner is in use.

### 10.3 Use of the roasting jack

In ovens it is possible to use the roasting-jack coupled with the functioning of the grill or of the oven.

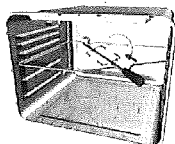

Place the food to be cooked on the spit-pole, blocking it with the two forks, being careful not to strain the starter with too heavy loads, and then proceed as follows:

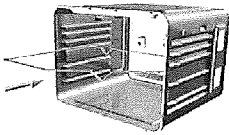

1) Place the frame inside the third guide starting from the bottom.

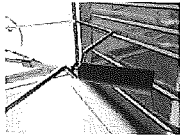

2) Position the pulley onto the frame so that it remains driven.

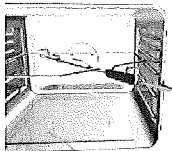

3) Remove the plastic handle by unscrewing it.

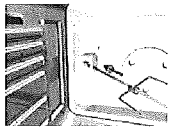

4) Introduce the frame with the food on the spit-pole until the pole point is inside the hole located on the oven rear wall.

5) Once cooking is completed, tighten the plastic handle to the spit to be able to extract it.



Position a pan on the first guide from the bottom and pour some water to avoid the formation of smoke.

## 11. Oven maintenance and cleaning



Disconnect the oven from the mains before every intervention which requests access to the live parts.

### 11.1 Cleaning the stainless steel

For a good preservation of the stainless steel, it must be cleaned regularly at the end of every use, once it has cooled down.

### 11.2 Daily routine cleaning

To clean and preserve the stainless steel surfaces, always use only specific products without abrasives.

Use instructions: pour the product on to a damp cloth and wipe the internal surface of the oven, accurately rinse and dry with a soft cloth.

## INSTRUCTIONS FOR THE USER



### 11.3 Food or residue stains

Never use metal sponges or sharp scrapers, the surfaces may be damaged.  
Use normal products for steel, non abrasive, eventually using tools made of plastic or wood material.  
Accurately rinse and dry with a soft cloth.  
Avoid letting sugary food residue dry inside the oven (ex. jam, chocolate, etc.).  
In time they may ruin the enamel coating the inside of the oven.



For a good preservation of the oven it must be cleaned regularly after it has cooled down.  
For easier cleaning, extract all removable parts.

### 11.4 Cleaning the oven (without self-cleaning panels)

Clean the oven pan support and the side guides with hot water and non abrasive detergents, rinse and dry (fig. 4).  
The door can be removed for easier cleaning (see point 11.8 "Dismantling of the door").

### 11.5 Glass door

To clean use kitchen absorbent paper, in case of persistent dirt, wash with a damp cloth and common detergent.  
We recommend keeping the glass of the door as clean as possible.

### 11.6 Extraordinary maintenance

The oven requires small maintenance interventions should, in time, those parts subject to wear, such as gaskets, lamp, etc, require replacing.  
Instructions for these types of interventions are supplied below.



Disconnect the oven from the mains before every intervention which requests access to the live parts.

### 11.7 Replacement of the internal lamp

Remove protection cover "A" by unscrewing it anti-clockwise, replace lamp "B" with a similar one (fig. 5).  
Mount the protection once again and screw it clockwise until it is tight.  
Only use oven lamps (T300°C) 15W or 25W depending on models.  
Never touch the lamp with bare fingers, always use protective gloves.  
Only use lamps obtained from authorised after-sales centres.



### 11.8 Dismantling of the door

Lift levers "1" up to the ledge with hinges "2" and hold the door at the two sides with both hands near the same hinges.

Lift the door upwards forming an angle of approx. 45° and carefully extract it.

For the mounting, place hinge "2" in the appropriate grooves, therefore leave the door to lean downwards, ensure it remains blocked in grooves "3", then release levers "1" (fig. 6).

### 11.9 Dismantling of oven door gaskets

To better clean the oven, the door gasket can be removed.

Before removing the gasket it is necessary to dismantle the oven door as described in paragraph 11.8 "Dismantling of the door".

With the door dismantled, lift the tongues located at the angles, as shown in the figure. Once cleaning is completed, re-mount the gaskets keeping the longest side horizontal and place the tongues in the respective holes, starting from the upper ones.

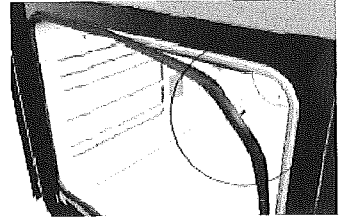

Fig. 1

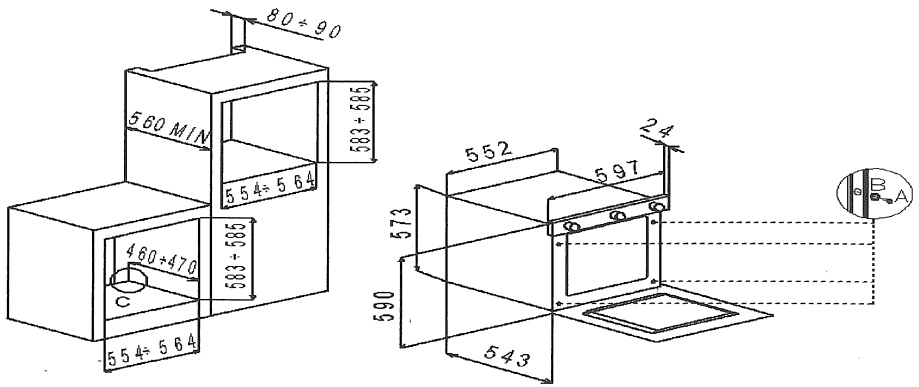

Fig. 2

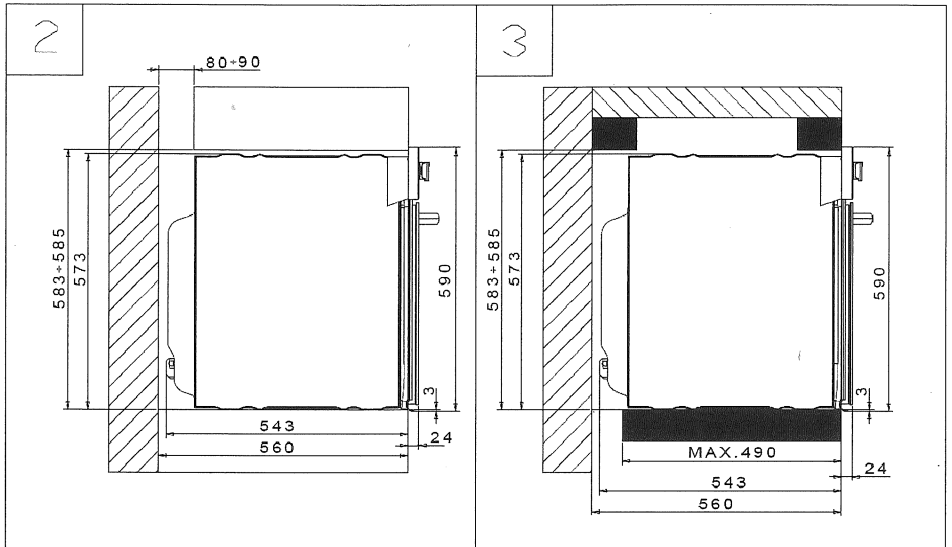

Fig. 3

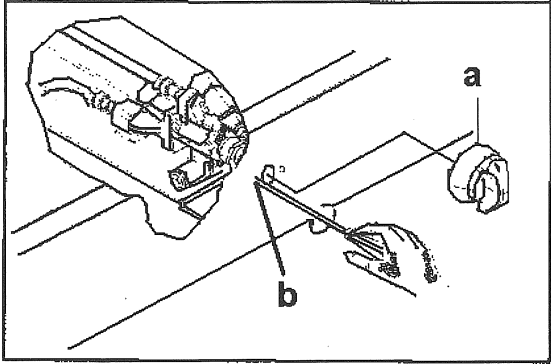

Fig. 4

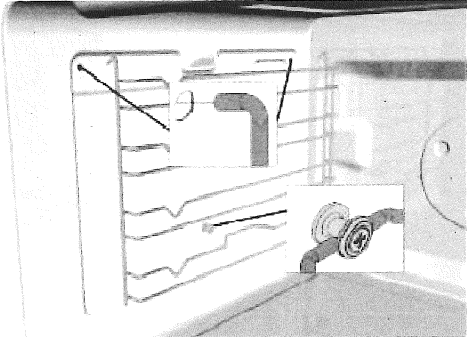
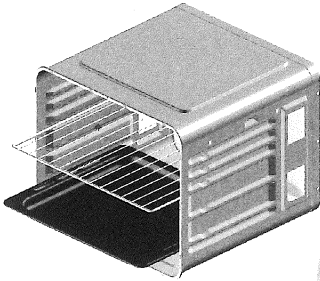

Fig. 5

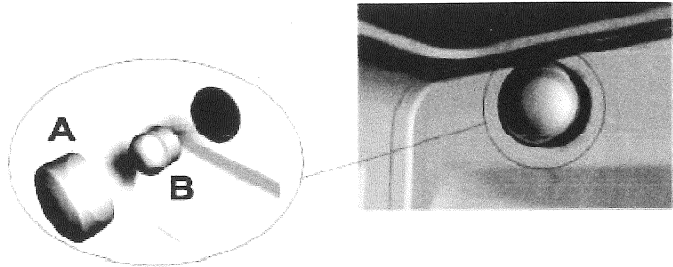
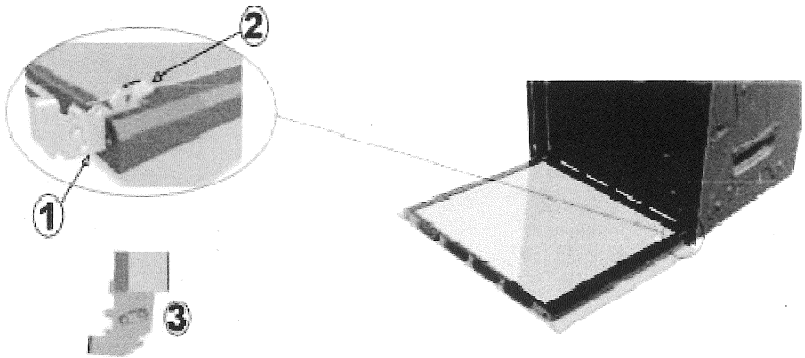

Fig. 6





010U04