

UNIVERSAL STACKING KIT

UNIVERSAL-STAPELSET

KIT DE SUPERPOSITION UNIVERSEL

UNIVERSELE STAPELKIT

UNIVERSAL SAMLESÆTTIL STABLING

YLEISVÄLISARJA

UNIVERSELT-STAPELKIT

UNIVERSELLT STAPELPAKET

KIT DE APILAMIENTO UNIVERSAL

KIT DE EMPILHAMENTO UNIVERSAL

STACKING KIT UNIVERSALE

UNIWEARSALNY ZESTAW MONTAŻOWY

KIT UNIVERSAL PENTRU MONTARE

ΚΙΤ ΣΤΟΙΒΑΞΗΣ ΓΕΝΙΚΗΣ ΧΡΗΣΗΣ

UNIVERZÁLNÍ STOHOVACÍ SADA

UNIVERSALUS KROVIMO BLOKAS

UNIVERSĀLAIS STIPRINĀJUMA KOMPLEKTS

UNIVERZÁLNA STOHOVACIA SADA

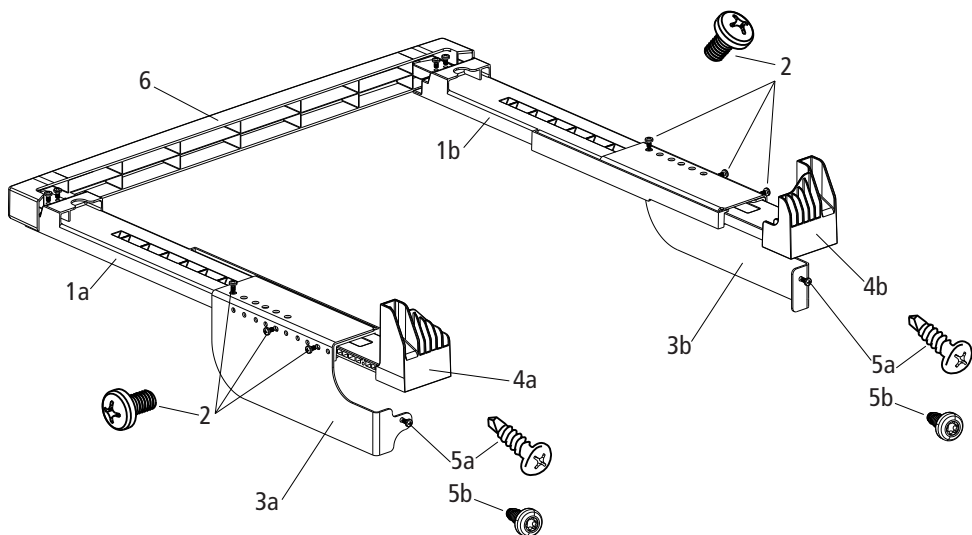

Universal Stacking Kit Kurulum Kılavuzu

Universal Stacking Kit Instruction Booklet

Universal-Stapelset – Anleitung

Guide d'utilisation du kit de superposition universel

Instructieboekje Universele Stapelkit

Manual til universalt samlesæt til stabling

Yleisvälisarjan ohjekirja

Universel Stabelkit brugsanvisning

Universellt stapelpaket, instruktionsbroschyr

Folleto de instrucciones del kit de apilamiento universal

Manual de instruções do kit de empilhamento universal

Libretto di istruzioni per stacking kit

Instrukcja użytkowania uniwersalnego zestawu montażowego

Broşură instrucţiuni kit universal pentru montare

Εγχειρίδιο Οδηγιών - Κιτ στοιβαξης γενικης χρησης

Návod k montáži univerzální stohovací sady

Universalaus krovimo bloko instrukcija

Universālā stiprinājuma komplekta uzstādīšanas instrukcija

Návod na montáž univerzálnej stohovacej sady

TÜRKÇE

Parça No	Parça İsmi	Parça No	Parça İsmi	Parça No	Parça İsmi
1	Sabitleme Kanalı	3	Arka Destek Bağlantı Sacı	5	a - Matkap Uçlu Sac Vidası b - Küt Uçlu Torx Vıda
2	Vidalar	4	Arka Sabitleyici	6	Kozmetik Görünüş Parçası

ADIM 1 :

Kutu içerisinden çıkan plastik sabitleme kanalı (1a-1b) parçalarını Çamaşır Makinesi (ÇM) üzerine şekildeki gibi yerleştirin. (1.1)

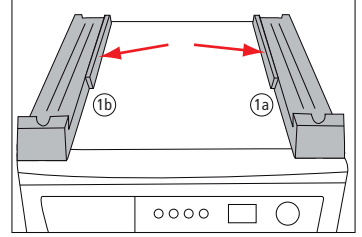

1.1

ADIM 2 :

Kozmetik görünüş parçasını (6) resimdeki gibi ön yüzeyde konumlayın. (2.1)

Daha sonra sağ ve sol sabitleme kanallarına (1), "kutu içerisindeki plastik vidaları kullanarak" 6 numaralı görünüş parçasının bağlantısını yapın. (2.2)



İpucu : Bu işlem için yıldız uçlu tornavida ya da şarjli el tabancası kullanın.

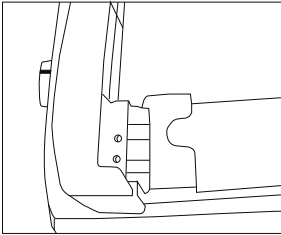

2.1

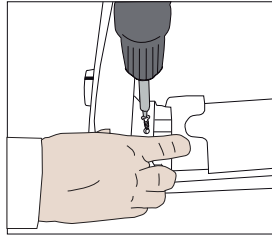

2.2

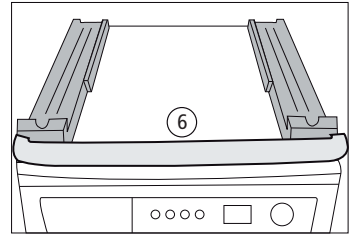

2.3

ADIM 3 :

Kozmetik görünüş parçasını (6) , ÇM üst tabla ile kozmetik şekilde uygun pozisyona getirin. (3.1 - 3.2)

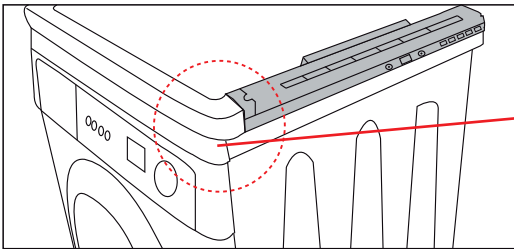

3.1

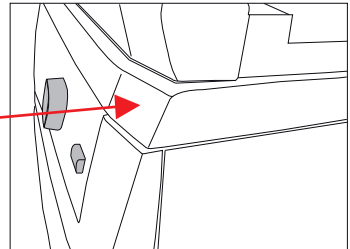

3.2

ADIM 4 :

Kozmetik ayarlamayı yaptıktan sonra , **arka destek bağlantı sacını** (3) ;

- İlk önce Şekil 4.1'de gösterildiği gibi , sabitleme kanalı (1) üzerinde konumlayın. (4.1)

- Daha sonra ÇM gövdesi üzerindeki delik pozisyonlarını konumlayın. (4.2)

İpucu 1 : Şekil 4.3'deki gibi , gösterilen kanal üzerine tam olarak oturduğundan emin olun.

İpucu 2 : Sabitleme kanalı (1) üzerinde hareket ettirerek uygun vida pozisyonunu bulun (4.4) ve plastik vidaları (2) gruplayın. (4.5)

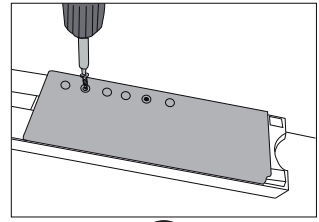
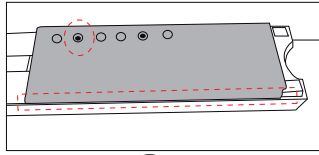
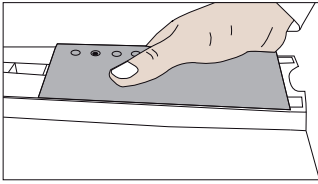
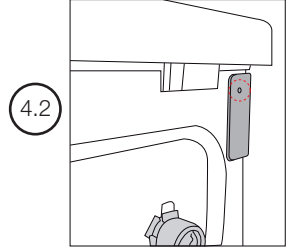
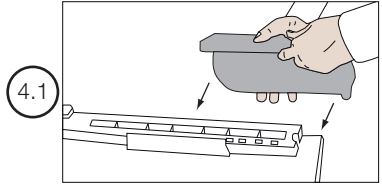

ADIM 5 :

Sabitleme kanalı (1a-1b) ile ÇM gövde bağlantısının yapılması için ,

- **Şekil 5.1**'de gösterildiği gibi (3a) parçasını ÇM gövdesi üzerine konumlandırıp bağlantıyı yapmak için , Stacking Kit grubu ile verilen matkap uçlu sac vidasını (5a) kullanın.

⚠ Bu adımdaki bağlantı için , **yalnızca 5a numaralı özel tasarım vida kullanılır ve montaj için 1 adet** kullanılır. (5.1)

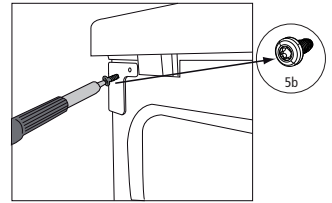
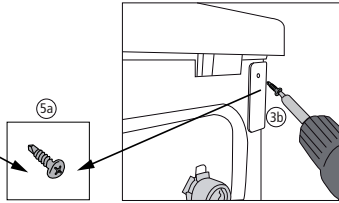
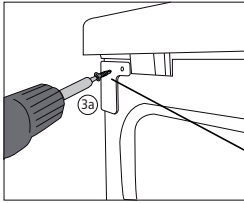

- **Şekil 5.2**'de gösterildiği gibi (3b) parçasını ÇM gövdesi üzerine konumlandırıp bağlantıyı yapmak için , matkap uçlu sac vidasını (5a) kullanın.

⚠ Bu adımdaki bağlantı için , **yalnızca 5a numaralı özel tasarım vida kullanılır ve montaj için 1 adet** kullanılır. (5.2)

⚠ Eğer gövde üzerinde montaj deliği varsa ; Matkap Uçlu Sac Vidası (5a) yerine , Küt Uçlu Torx Vida (5b) kullanılmalıdır. (5.3)

ADIM 6 :

Kurutma Makinesi'ni (KM) , Çamaşır Makinesi (ÇM) ve Stacking Kit grubu üzerine oturtmak için;

⚠ Kurutma Makinesi'nin 4 adet ayarlı ayağını 4 ila 6 tam tur çevirerek açın. (6.1)

- En az 2 kişi ile Kurutma Makinesi'ni (KM) kaldırarak, sabitleme kanalı (1) üzerine oturtun. (6.2)

⚠ Ayarlı ayaklar açıldıktan sonra KM'nin dengesi kontrol edilmelidir.

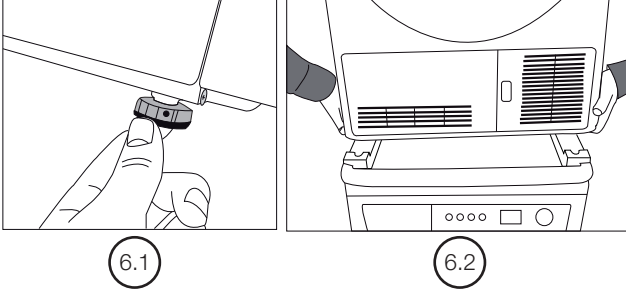

ADIM 7 :

Kurutma Makinesi'ni (KM) sabitleme kanalları (1) üzerinde öne doğru kaydırın. (7.1)

Ön ayarlı ayakları , sabitleme kanalı (1) üzerindeki kanala oturup sabit durana kadar kaydırma işlemine devam edin. (7.2)

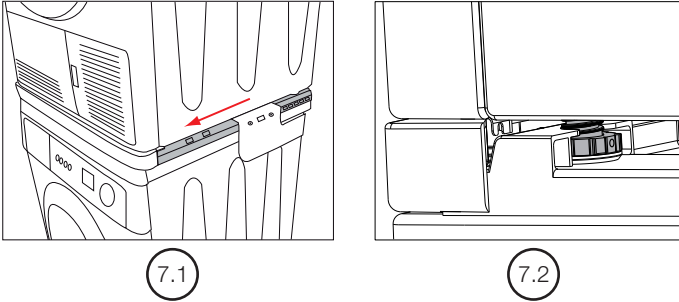

ADIM 8 :

Resimde gösterilen PT vidaları , sağ ve sol taraftan sökün. Bu vidalar daha sonra kullanılacaktır. (8.1)

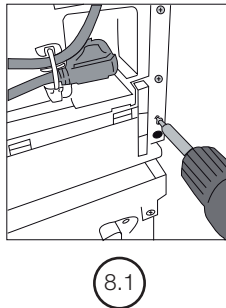

ADIM 9 :

KM ve Stacking Kit grubu bağlantısının yapılması için ;

- KM'yi arka bölgeden öne doğru iterek kaldırm. Arka sabitleme parçasını (4) sabitleme kanalı (1) parçasına takın. (9.1)

⚠ Arka sabitleme parçaları (4a-4b) sağ ve sol olmak üzere 2 tiptir. Ters yönlü montajı yapılamaz.

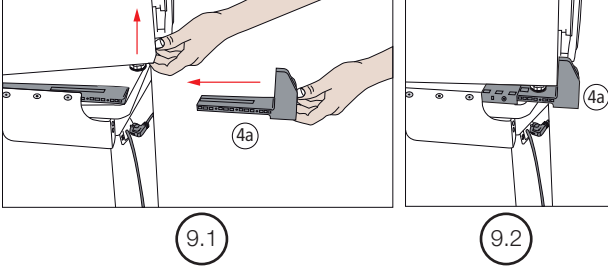

ADIM 10 :

KM derinliğine göre arka sabitleme parçalarını (4a-4b) , sabitleme kanalı (1a-1b) içerisinde hareket ettirin.

- Bu ayarlardan sonra , Adım 8'de sökülen vidaları tekrar kullanarak arka sabitleyici parçalarını KM gövdesine sabitleyin. (10.1)

⚠ Vida bağlantısı sırasında yalnızca yıldız uçlu tornavida kullanın.

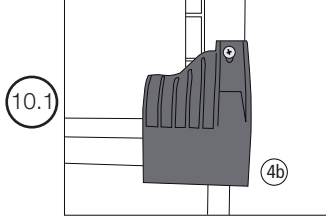

ADIM 11 :

ÇM, KM ve Stacking Kit grubu bağlantılarının tamamlanması için;

- 1 ve 3 numaralı parçalar arasında karşılıklı gelen delikleri eşleştirin ve eşleşen bu deliklere plastik vidalar (2) ile bağlantı yapın. (11.1)

- Bu işlemi her iki yönde yaparak Stacking Kit kurulumunu tamamlayın.

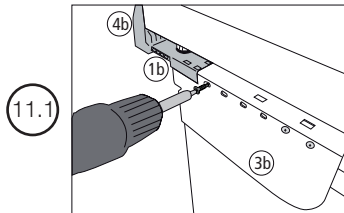

ENGLISH

Part No	Part Name	Part No	Part Name	Part No	Part Name
1	Retaining Ducts	3	Rear Support Connection Part	5	a - Self tapping Screws b - Butt-End Torx Screw
2	Screws	4	Rear Fixing Element	6	Cosmetic Appearance Part

STEP 1 :

Place the plastic retaining (1a-1b) parts delivered in the box on the Washing Machine (WM) as shown in the figure. (1.1)

Hint : Geometric surfaces on the figure shall be faced against each other.

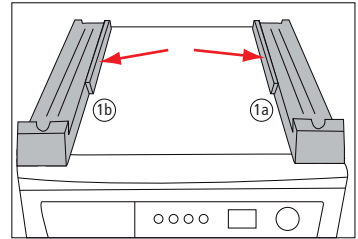

1.1

STEP 2 :

Place the cosmetic appearance part (6) on the front face as shown in the figure. (2.1)

Then use the “for plastics screws supplied in the box” to perform the connection of the appearance part (6) to the left and right retaining ducts (1). (2.2)

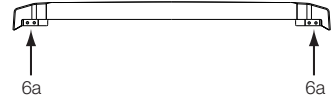

6a

6a

Hint : Use powered screwdriver for this operation.

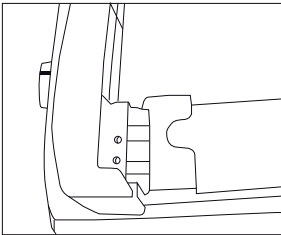

2.1

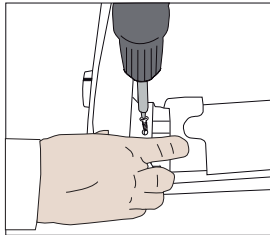

2.2

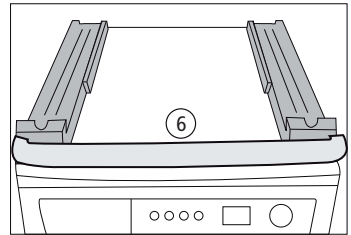

2.3

STEP 3 :

Align the cosmetic appearance part (6) to the cosmetically proper position with WM upper tray. (3.1 - 3.2)

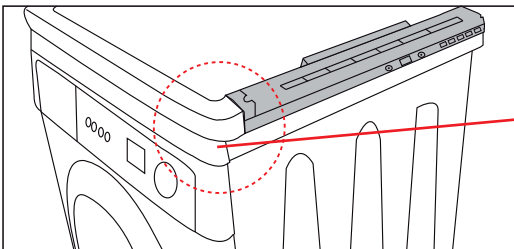

3.1

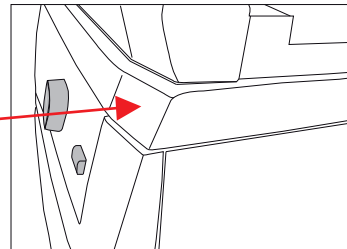

3.2

STEP 4 :

Place the rear support plate (3) ;

- on the retaining duct (1) as shown in figure 4.1 first. (4.1)
- Then adjust the hole positions on the WM body. (4.2)

Hint 1 : As shown in figure 4.3, ensure that it properly seated on the duct shown.

Hint 2 : Find the proper screw position (4.4) by moving it on the retaining duct (1) and mount them with the plastic screws (2). (4.5)

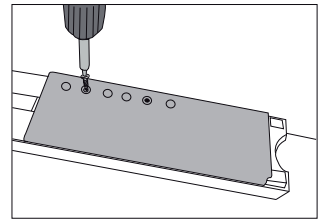
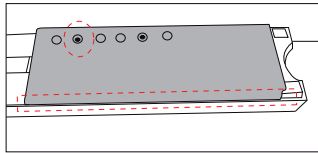
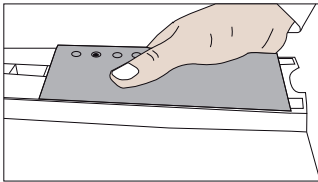
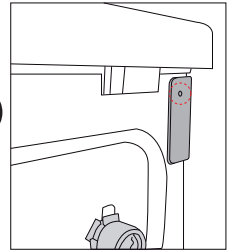
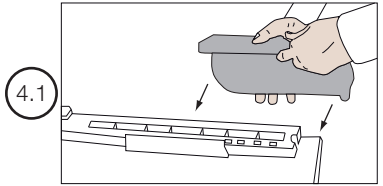

STEP 5 :

In order to make the retaining duct (1a-1b) to WM body connection,

- As shown in figure 5.1, use the self tapping screw (5a) delivered with Stacking Kit assembly in order to position the (3a) part on the WM body and perform the connection.

⚠ For the connection in this step, **special design no. 5a screw is used only and 1 piece is used for** the installation. (5.1)

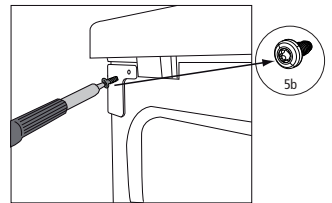
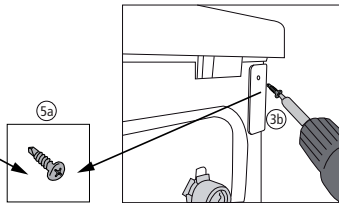
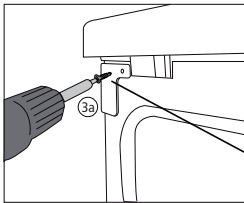

- As shown in figure 5.2, use the self tapping screw (5a) delivered with Stacking Kit assembly in order to position the (3b) part on the WM body and perform the connection.

⚠ For the connection in this step, **special design no. 5a screw is used only and 1 piece is used for** the installation. (5.2)

⚠ If there is an installation hole on the body; use butt-end torx screw (5b) instead of drill-bit self-tapping screw (5a). (5.3)

STEP 6 :

In order to place the Tumble Dryer (TD) on the Washing Machine (WM) and Stacking Kit assembly;

⚠ Firstly open 4 adjustable feet of Tumble Dryer (TD) by rotating them for 4-6 turns. (6.1)

- Lift the Tumble Dryer (TD) with two persons at least, and place it on the retaining duct (1). (6.2)

⚠ Check the stability of TD after opening the feet.

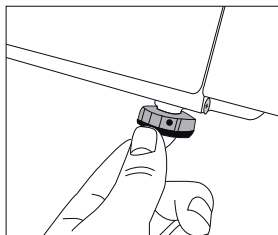

6.1

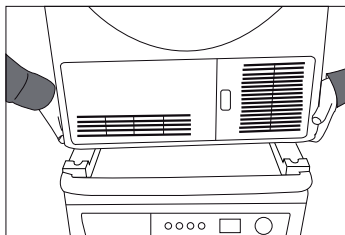

6.2

STEP 7 :

Move the Tumble Dryer (TD) forward on retaining ducts (1). (7.1)

Continue to slide the machine until feet are placed and secured on the duct over the retaining duct (1). (7.2)

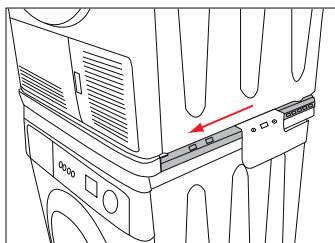

7.1

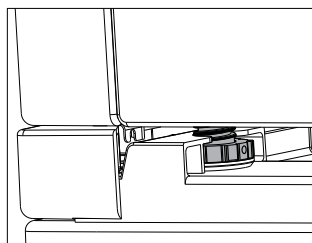

7.2

STEP 8 :

Remove the PT screws from the rearside body of TD as shown in the figure from left and right side. These screws shall be used later. (8.1)

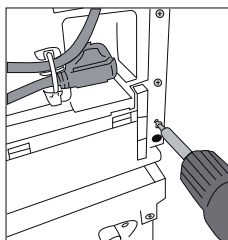

8.1

STEP 9 :

For the connection of TD and Stacking Kit assembly;

- Lift the TD by pushing it forward from the rear area. Install the rear fixing part (4) to retaining duct (1) part. (9.1)

 Rear retaining parts (4a-4b) have two types: left and right. Installation in the reverse direction is not possible. Because rear fixing parts designed as left and right. (4a-4b)

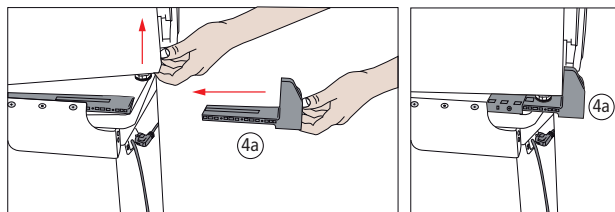

9.1

9.2

STEP 10 :

Move the rear fixing parts (4a-4b) inside the retaining duct (1a-1b) as per the depth of TD.

- After this adjustment, use the screws removed in step 8 to secure rear retaining parts to TD body. (10.1)

 Use powered screwdrivers only during screw connection.

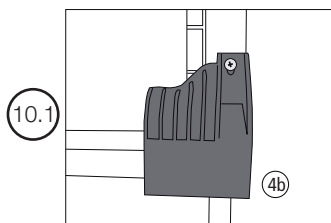

STEP 11 :

In order to complete the WM, TD and Stacking Kit assembly connections;

- Match the corresponding holes between parts no. 1 and 3 and connect these matching holes (2) with plastic screws. (11.1)

- Complete Stacking Kit installation by making this operation in both directions.

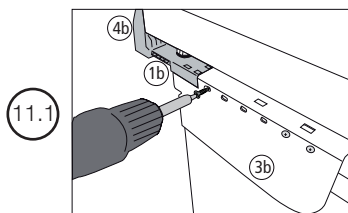

DEUTSCH

Teilenummer	Teilebezeichnung	Teilenummer	Teilebezeichnung	Teilenummer	Teilebezeichnung
1	Führungen	3	Verbindungsteil, hintere Halterung	5	a - Selbstschneidende Schrauben b - Kolbenende-Torxschraube
2	Schrauben	4	Hinteres Befestigungselement	6	Zierblende

Schritt 1:

Bringen Sie die mitgelieferten Kunststoffführungen (1a/1b) wie abgebildet an der Waschmaschine (WM) an. (1.1)

Tip : Geometrische Flächen in der Abbildung sollten sich gegenüberliegen.

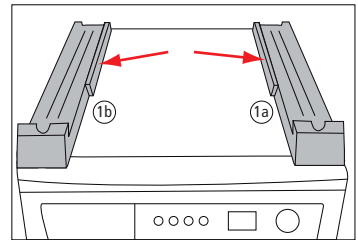

(1.1)

Schritt 2:

Bringen Sie die Zierblende (6) wie abgebildet an der Vorderseite an. (2.1)

Verbinden Sie die Zierblende (6) dann mit den mitgelieferten Kunststoffschrauben zum an der linken und rechten Führung (1). (2.2)

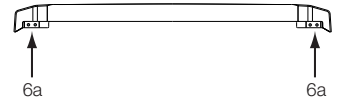

Tip : Verwenden Sie dazu einen Akkuschaubendreher.

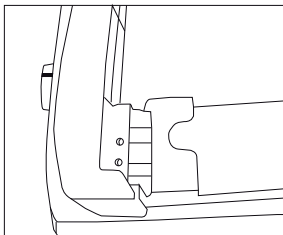

(2.1)

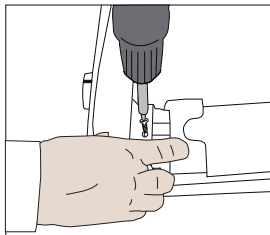

(2.2)

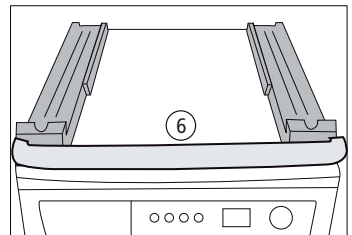

(2.3)

Schritt 3:

Richten Sie die Zierblende (6) an der geeigneten Position am oberen Waschmaschinenfach aus. (3.1 - 3.2)

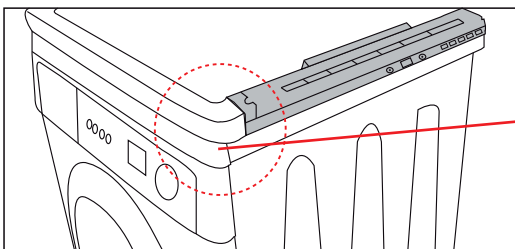

(3.1)

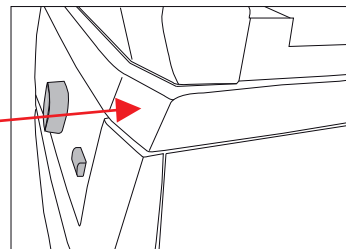

(3.2)

Schritt 4:

So bringen Sie die hintere Halteplatte an (3):

- Bringen Sie sie zuerst wie in Abbildung 4.1 gezeigt an der Führung (1) an. (4.1)

- Richten Sie dann die Lochpositionen an der Waschmaschine aus. (4.2)

Tippt 1 : Stellen Sie sicher, dass sie wie in Abbildung 4.3 gezeigt richtig am Rohr angebracht ist. (4.2)

Tippt 2 : Suchen Sie nach der geeigneten Schraubposition (4.4), indem Sie sie an der Führung (1) verschieben; montieren Sie sie mit den Kunststoffschrauben (2). (4.5)

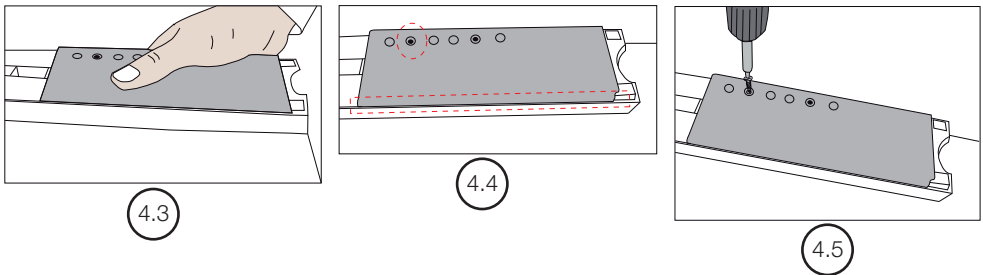

Schritt 5:

So verbinden Sie die Führung (1a-1b) mit der Waschmaschine:

- Verbinden Sie das Befestigungsteil (3a) mit der im Montageset enthaltenen selbstschneidenden Schraube wie in Abbildung 5.1 gezeigt mit der Waschmaschine.

⚠ In diesem Schritt wird zur Montage nur **die speziell konzipierte Schraube Nr. 5a eingesetzt**; für die Installation wird **1 Schraube verwendet**. (5.1)

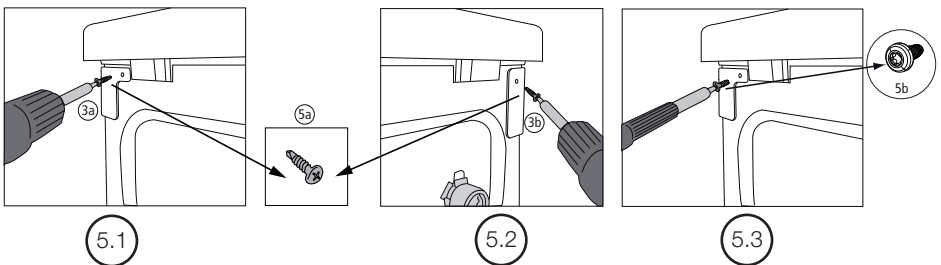

- Verbinden Sie das Befestigungsteil (3b) mit der im Montageset enthaltenen selbstschneidenden Schraube wie in Abbildung 5.2 gezeigt mit der Waschmaschine.

⚠ In diesem Schritt wird zur Montage nur **die speziell konzipierte Schraube Nr. 5a eingesetzt**; für die Installation wird **1 Schraube verwendet**. (5.2)

⚠ Falls sich ein Installationsloch im Gehäuse befindet, verwenden Sie die selbstschneidende Torx-Schraube mit dickem Ende (5b) anstatt der selbstschneidenden Bohrer-Schraube (5a). (5.3)

Schritt 6:

So bringen Sie den Trockner auf der mit dem Montageset versehenen Waschmaschine an:

 Öffnen Sie zunächst die 4 höhenverstellbaren Füße des Trockners, indem Sie diese 4- bis 6-mal um die eigene Achse drehen. (6.1)

- Heben Sie den Trockner mindestens zu zweit an und stellen ihn auf die Führung (1). (6.2)

 Prüfen Sie die Stabilität des Trockners nach Öffnen der Füße.

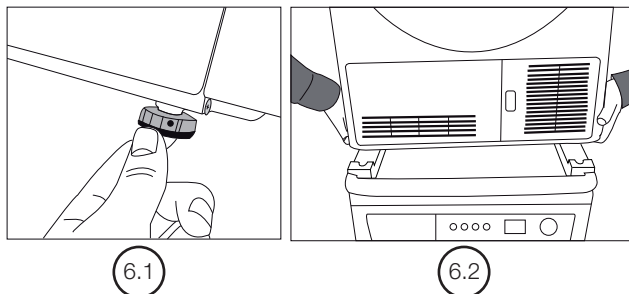

Schritt 7:

Schieben Sie den Trockner auf den Führungen (1) nach vorne. (7.1)

Schieben Sie das Gerät so weit, bis die Füße auf der Leiste über der Führung (1) positioniert und gesichert sind. (7.2)

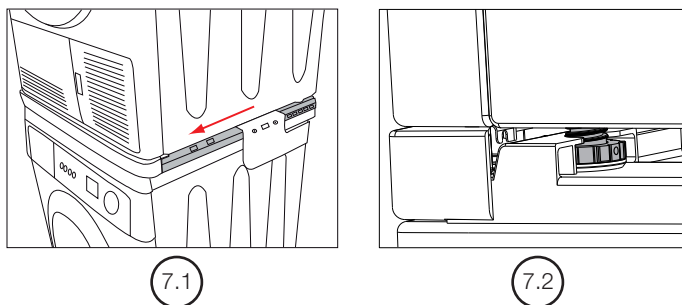

Schritt 8:

Entfernen Sie die Kunststoffschrauben wie abgebildet über die linke und rechte Seite von der Rückseite des Trockners. Diese Schrauben werden später benötigt. (8.1)

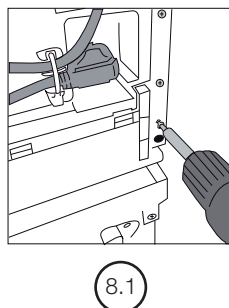

Schritt 9:

So verbinden Sie Trockner und Montageset:

- Heben Sie den Trockner an, indem Sie ihn von hinten nach vorne drücken. Installieren Sie das hintere Befestigungsteil (4) an der Führung (1). (9.1)

 Es gibt zwei hintere Befestigungsteile (4a/4b): Links und rechts. Eine seitenverkehrte Installation ist nicht möglich, da die hinteren Befestigungsteile für die linke bzw. rechte Seite ausgelegt sind. (4a/4b)

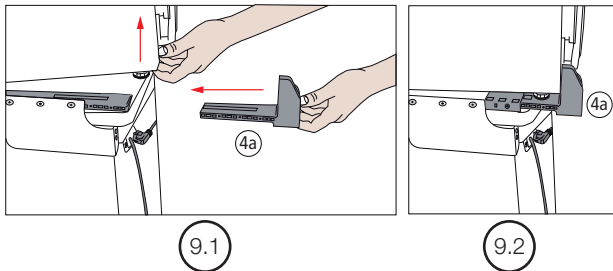

Schritt 10:

Verschieben Sie die hinteren Befestigungsteile (4a/4b) in der Führung (1a/1b) entsprechend der Tiefe des Trockners (TD).

- Verwenden Sie anschließend die in Schritt 8 entfernten Schrauben zur Befestigung der hinteren Befestigungsteile am Trockner. (10.1)

 Verwenden Sie zur Montage immer einen Akkuschaubendreher.

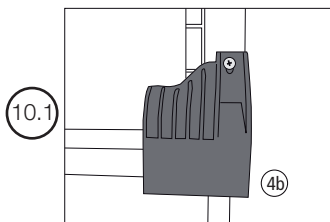

Schritt 11:

So schließen Sie die Verbindung von Waschmaschine, Trockner und Montageset ab:

- Bringen Sie die entsprechenden Löcher der Teile 1 und 3 in Übereinstimmung und verbinden diese (2) mit Kunststoffschrauben. (11.1)

- Schließen Sie die Installation des Montagesets ab, indem Sie den Vorgang in beide Richtungen durchführen.

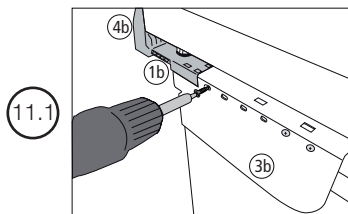

FRANÇAIS

Pièce n°	Désignation des pièces	Pièce n°	Désignation des pièces	Pièce n°	Désignation des pièces
1	Barres de fixation	3	Pièce de raccordement de support arrière	5	a - Vis à auto-taraudage b - Vis Torx avec embout
2	Vis	4	Élément de fixation arrière	6	Pièce d'apparence esthétique

ÉTAPE 1 :

Placez les pièces de maintien en plastique (1a-1b) livrées dans la boîte sur la machine à laver (WM), comme indiqué sur la figure. (1.1)

Conseil : Les surfaces géométriques sur la figure doivent être placées face à face.

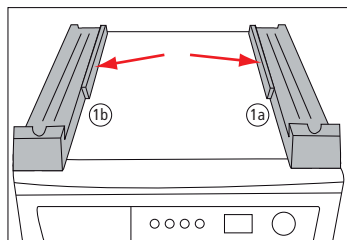

(1.1)

ÉTAPE 2 :

Placez la partie d'apparence esthétique (6) sur la face avant comme indiqué sur la figure. (2.1)

Puis utiliser les « vis en plastique fournies dans la boîte » pour effectuer le raccordement de la partie apparente (6) aux barres de fixation gauche et droite (1). (2.2)

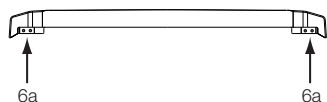

Conseil : Utilisez un tournevis électrique pour cette opération.

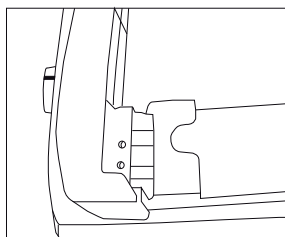

(2.1)

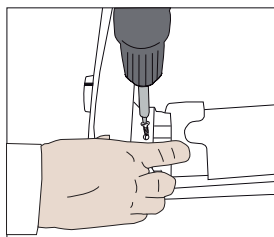

(2.2)

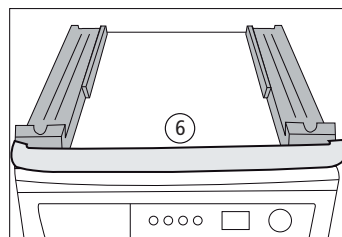

(2.3)

ÉTAPE 3 :

Placez la partie d'apparence esthétique (6) dans la position correcte de manière harmonieuse sur le plateau supérieur de la WM. (3.1 - 3.2)

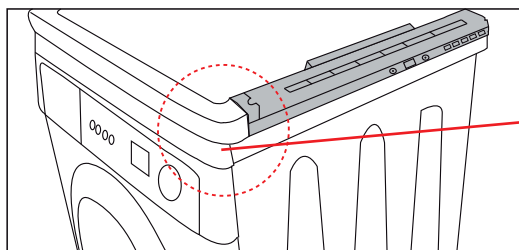

(3.1)

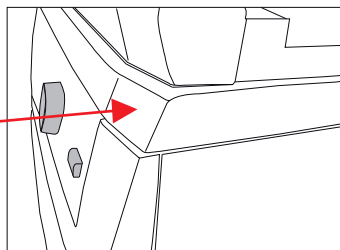

(3.2)

ÉTAPE 4 :

Placez la plaque de support arrière (3) ;

- sur la barre de fixation (1) comme l'indique la figure 4.1
premièrement. (4.1)

- Puis ajustez la position des orifices sur la coque de la WM.
(4.2)

Conseil 1 : Comme le montre la figure 4.3, assurez-vous
qu'elle est correctement fixée sur la barre indiquée.

Conseil 2 : Trouvez la position adéquate de la vis (4.4)
en déplaçant la plaque sur la barre de fixation (1), ensuite,
montez-la avec des vis en plastique (2). (4.5)

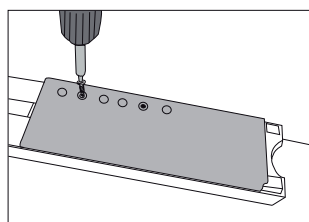
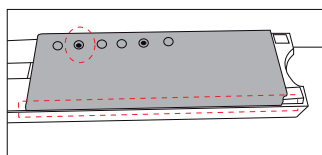
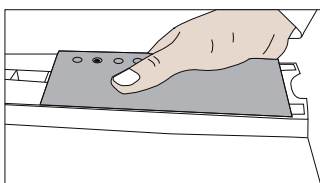
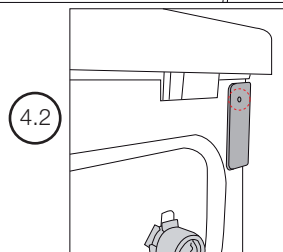
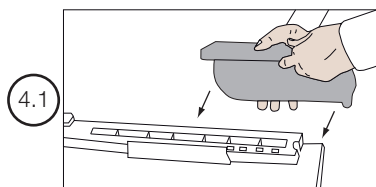

ÉTAPE 5 :

Pour effectuer le raccordement de la barre de fixation (1a-1b) à la coque de la WM,

- comme le montre la figure 5.1, utilisez la vis à auto taraudage (5a) livrée avec le montage du kit de superposition afin de positionner la pièce (3a) sur la coque de la WM et procéder au raccordement.

⚠ Pour le raccordement à cette étape, la vis n°5a spécialement conçue est la seule utilisée
et **1 pièce est utilisée** pour l'installation. (5.1)

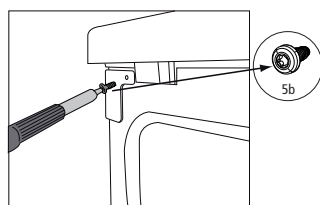
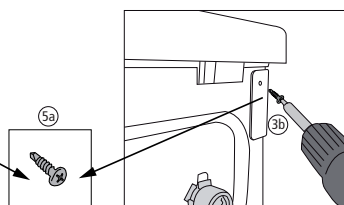
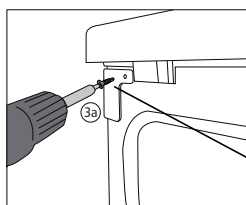

- comme le montre la figure 5,2, utilisez la vis à auto taraudage (5a) livrée avec le montage du kit de superposition afin de positionner la pièce (3b) sur la coque WM et procéder au raccordement.

⚠ Pour le raccordement à cette étape, la vis n°5a spécialement conçue est la seule utilisée
et **1 pièce est utilisée** pour l'installation. (5.2)

⚠ Si la coque est pourvue d'un trou d'installation, utilisez la vis Torx avec embout (5b) plutôt que
la vis à autotaraudage avec mèche de perçage (5a). (5.3)

ÉTAPE 6 :

Afin de placer le sèche-linge (TD) et le montage du kit de superposition sur la machine à laver (WM) ;

⚠ Dévissez d'abord les 4 pieds réglables du sèche-linge (TD) en les faisant tourner 4 à 6 fois. (6.1)

- Soulevez le sèche-linge (TD) avec l'aide d'au moins deux personnes, et placez-le sur les barres de fixation (1). (6.2)

⚠ Vérifiez la stabilité du TD après avoir dévissé le pied.

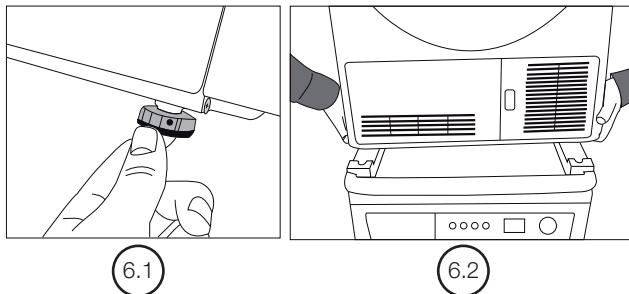

ÉTAPE 7 :

Déplacez le sèche-linge (TD) vers l'avant sur les barres de fixation (1). (7.1)

Continuer à faire coulisser l'appareil jusqu'à ce que ses pieds s'encastrent dans l'ouverture avant des barres de fixation (1). (7.2)

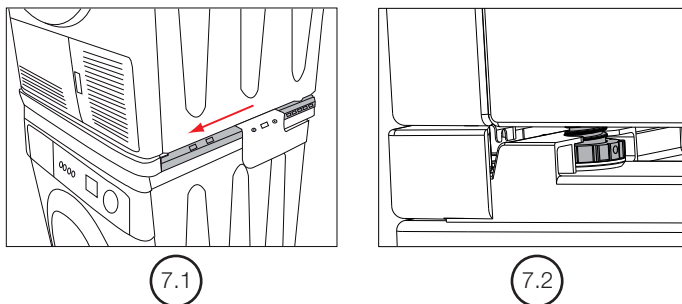

ÉTAPE 8 :

Retirez les vis PT à gauche et à droite de la face arrière de la coque du TD comme indiqué sur la figure. Ces vis seront utilisées plus tard. (8.1)

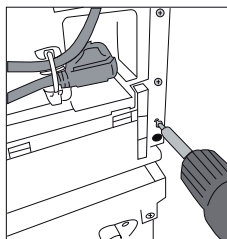

8.1

ÉTAPE 9 :

Pour le raccordement du TD et du montage du kit de superposition ;

-Soulevez le TD en le poussant vers l'avant à partie de la zone arrière. Installez la pièce de fixation arrière (4) sur les barres de fixation (1). (9.1)

 Les pièces fixation arrière (4a-4b) sont de deux types : gauche et droite. L'installation dans le sens contraire est impossible. Car les pièces de fixation arrière sont conçues pour la gauche et la droite. (4a-4b)

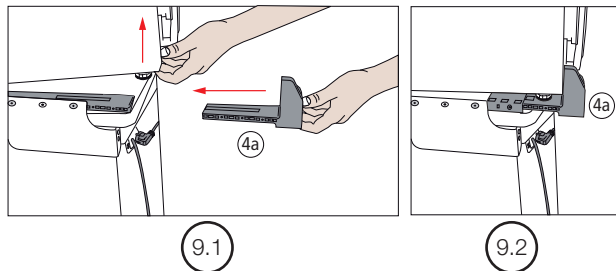

ÉTAPE 10 :

Déplacez les pièces de fixation arrière (4a-4b) à l'intérieur de la barre de fixation (1a-1b) selon la profondeur du TD.

- Après ce réglage, utilisez les vis enlevées à l'étape 8 pour monter les pièces de fixation arrière sur la coque du TD. (10.1)

 Utilisez les tournevis électriques uniquement lors du raccordement des vis.

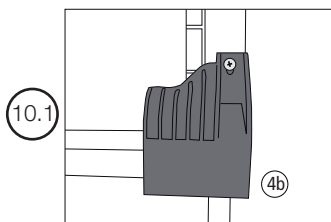

ÉTAPE 11 :

Afin de terminer les raccordements de la WM, du TD et du montage du kit de superposition ;

- Appariez les orifices correspondants entre les parties n°1 et 3 et raccordez-les (2) avec les vis en plastique (11.1)

- Terminez l'installation du kit de superposition en effectuant cette opération dans les deux sens.

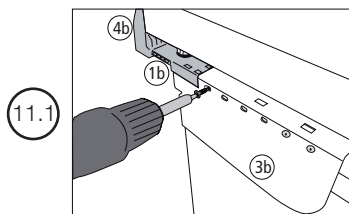

VLAAMS

Onderdeel-nummer	Onderdeelnaam	Onderdeel-nummer	Onderdeelnaam	Onderdeel-nummer	Onderdeelnaam
1	Vasthoudende goten	3	Ondersteuningsverbinding achter	5	a - Zelftappende schroeven b - Schroef met knopuiteinde
2	Schroeven	4	Bevestigingsonderdeel achter	6	Zichtbaar deel

STAP 1 :

Plaats de plastic bevestigonderdelen (1a-1b) die zich in de doos van de wasmachine (WM) bevinden zoals getoond in de afbeelding. (1.1)

Tip : De meetkundige oppervlakken op de afbeelding moeten tegenover elkaar worden geplaatst.

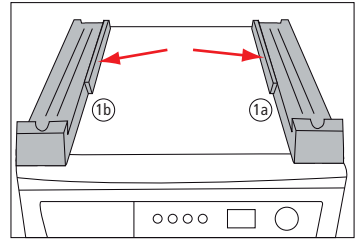

(1.1)

STAP 2 :

Plaats het toonbare gedeelte (6) naar de voorkant zoals getoond in de afbeelding. (2.1)

Maak dan gebruik van de “plastic schroeven die in de doos zijn meegeleverd” om de verbinding van het toonbare onderdeel (6) links en rechts aan de vasthoudende goten (1) uit te voeren. (2.2)

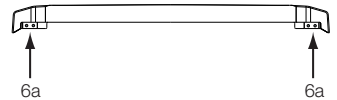

Tip : Gebruik een elektrische schroevendraaier voor deze handeling.

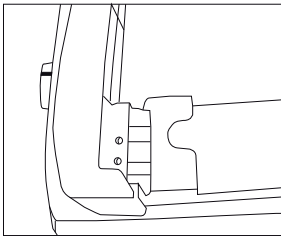

(2.1)

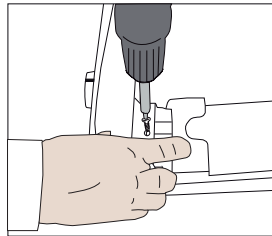

(2.2)

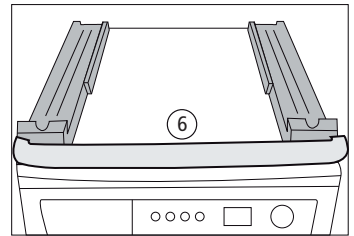

(2.3)

STAP 3 :

Lijn het toonbare onderdeel (6) uit het met de geschikte toonbare positie van het WM-bovenblad. (3.1 - 3.2)

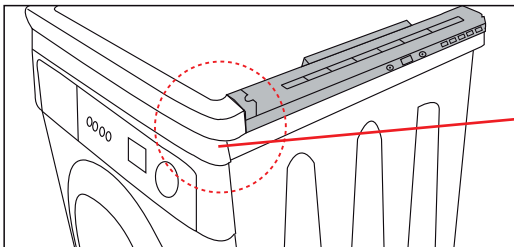

(3.1)

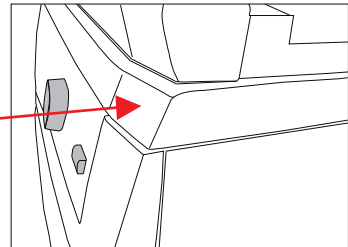

(3.2)

STAP 4 :

Plaats de ondersteunende plaat (3) van de achterkant;

- op de vasthoudende goot (1) zoals in afbeelding 4.1 getoond eerst. (4.1)

- Pas daarna de gehele positie van de WM-behuizing aan. (4.2)

Tip 1 : Zorg dat het goed is bevestigd op de getoonde goot zoals weergegeven in afbeelding 4.3.

Tip 2 : Zoek de juiste schroefpositie (4.4) door deze over de vasthoudende goot (1) te bewegen en bevestig deze met de plastic schroeven (2). (4.5)

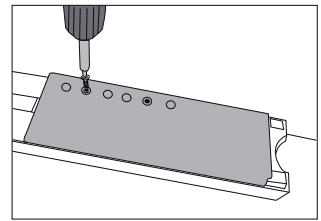
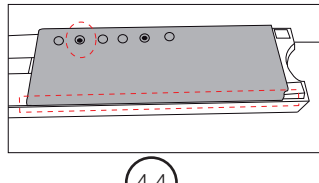
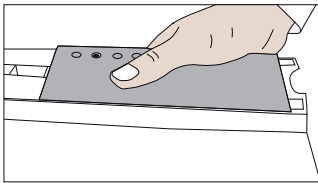
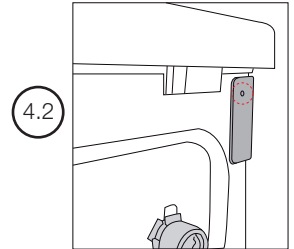
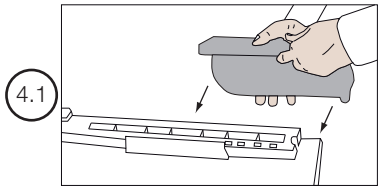

STAP 5 :

Om de vasthoudende goot (1a-1b) op de WM-behuizing vast te maken,

- Gebruik zoals weergegeven in afbeelding 5.1 de zelftappende schroeven (5a) die met de montagekit zijn meegeleverd om het (3a) onderdeel op de WM-behuizing te plaatsen en de verbinding tot stand te brengen.

⚠ Voor de verbinding van deze stap wordt alleen speciaal ontwerp schroef nummer 5a gebruikt en 1 stuks wordt gebruikt voor de installatie. (5.1)

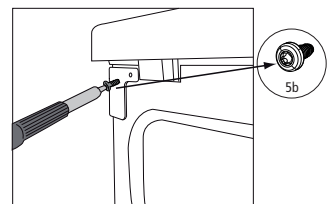
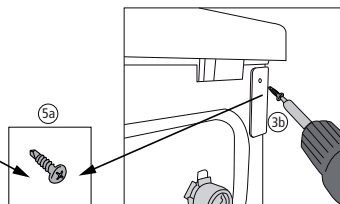
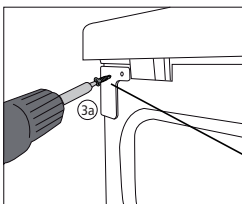

- Gebruik zoals weergegeven in afbeelding 5.2 de zelftappende schroeven (5a) die met de montagekit zijn meegeleverd om het (3b) onderdeel op de WM-behuizing te plaatsen en de verbinding tot stand te brengen.

⚠ Voor de verbinding van deze stap wordt alleen speciaal ontwerp schroef nummer 5a gebruikt en 1 stuks wordt gebruikt voor de installatie. (5.2)

⚠ Als er zich een installatiegat op de behuizing bevindt; gebruik een Torx-schroef met dik uiteinde (5b) in plaats van een boorbeitel met zelftappende schroef (5a). (5.3)

STAP 6 :

Om de droogtrommel (DT) op de wasmachine (WM) en de montagekit te plaatsen;

 Draai eerst de 4 verstelvoetjes van de droogtrommel (DT) los door ze 4-6 keer te draaien. (6.1)

- Til de droogtrommel (DT) met minstens twee personen, en plaats deze om de vasthoudende goot (1). (6.2)

 Controleer de stabiliteit van de DT na het losdraaien van de voetjes.

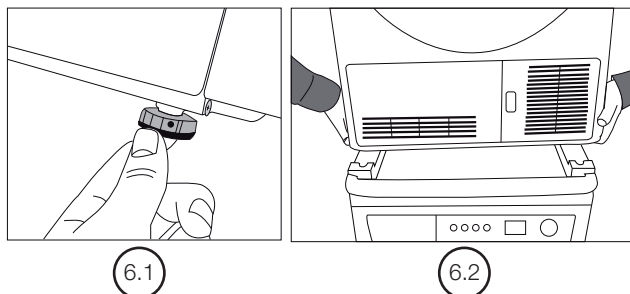

STAP 7 :

Beweeg de droogtrommel (DT) naar voren op de vasthoudende gooten (1). (7.1)

Glij de machine verder totdat de voetjes op de goot van de vasthoudende goot zijn geplaatst en vergrendeld (1). (7.2)

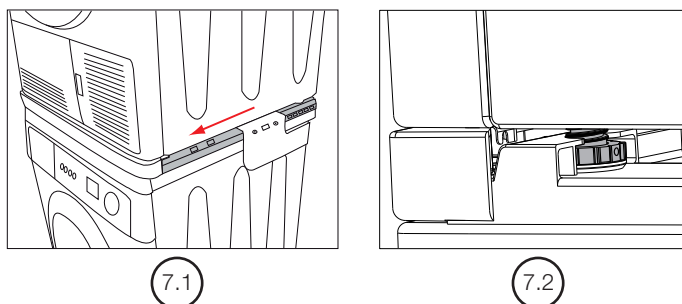

STAP 8 :

Verwijder de PT-schroeven van de achterkant van de DT-behuizing uit de linker- en de rechterkant zoals getoond in de afbeelding. Deze schroeven zullen later gebruikt worden. (8.1)

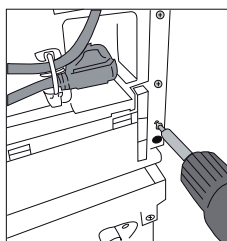

8.1

STAP 9 :

Voor de verbinding van de DT en de montagekit;

- Til de DT op door deze naar voren te duwen vanaf de achterkant. Installeer het bevestigingsonderdeel van de achterkant (4) aan het deel van de vasthoudende goot (1). (9.1)

! De vasthoudende onderdelen aan de achterkant (4a-4b) zijn er in twee soorten: links en rechts. Omgekeerde installatie is niet mogelijk. De bevestigingsonderdelen zijn ontworpen als linker en rechter. (4a-4b)

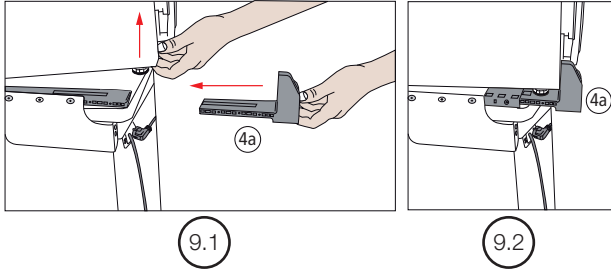

STAP 10 :

Beweeg de bevestigende onderdelen aan de achterkant (4a-4b) in de vasthoudende goot (1a-1b) naar gelang de diepte van de droogtrommel (DT).

- Gebruik na deze aanpassing de schroeven verwijderd in stap 8 om de vasthoudende onderdelen van de achterkant aan de DT-behuizing te bevestigen. (10.1)

! Gebruik bij de schroevenverbinding uitsluitend een elektrische schroevendraaier.

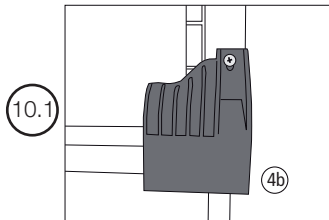

STAP 11 :

Om de verbindingen van de WM, DT en montagekitverbindingen te voltooien;

- Breng de overeenstemmende gaten tussen onderdeelnummers 1 en 3 samen en verbind deze overeenstemmende gaten (2) met plastic schroeven. (11.1)

- Voltooi de installatie van de montagekit door deze handeling in beide richtingen te doen.

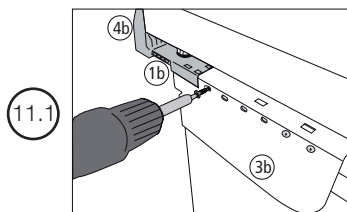

DANSK

Delnr.	Delnavn	Delnr.	Delnavn	Delnr.	Delnavn
1	Støttekanaler	3	Bagerste støtteforbindelsesdel	5	a - Selvskærende skruer b - Butt-End Torxskruer
2	Skruer	4	Bagerste fastgørelseelement	6	Pyntedel

TRIN 1 :

Placér de plastik fastholdende dele (1a-1b), som blev leveret i kassen, oven på vaskemaskinen, som vist i figuren. (1.1)

Tip : Geometriske overflader på figuren skal vende mod hinanden.

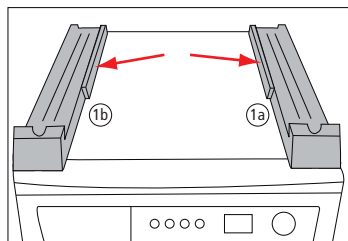

1.1

TRIN 2 :

Anbring pyntedelen (6) i fronten, som vist i figuren. (2.1)

Brug derefter "til plastikskrue leveret i kassen" for at forbinde pyntedelen (6) med venstre og højre støttekanaler (1). (2.2)

Tip : Brug en el-skruetrækker til denne handling.

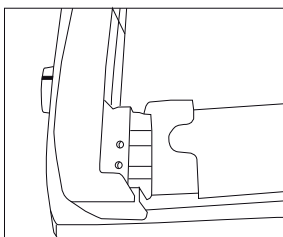
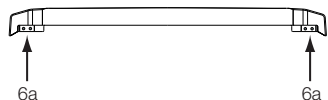

2.1

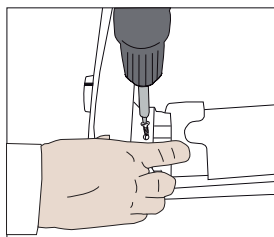

2.2

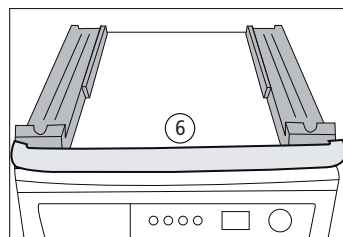

2.3

TRIN 3 :

Justér pyntedelen (6), så den flugter med vaskemaskinens øverste bakke. (3.1 - 3.2)

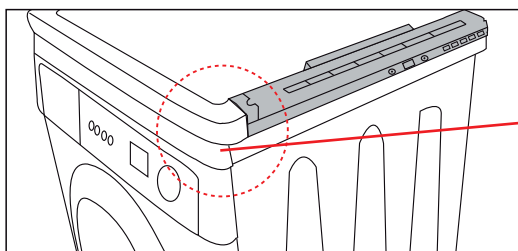

3.1

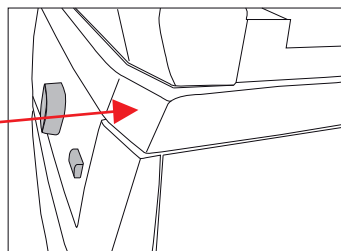

3.2

TRIN 4 :

Anbring den bagerste støtteplade (3) ;

- først på støttekanalen (1), som vist i figur 4.1. (4.1)
- Justér derefter hele placeringen på vaskemaskinens kabinet. (4.2)

Hint 1 : Sørg for, at anretningen sidder fast i kanalen, som vist i figur 4.3.

Hint 2 : Find den korrekte skrueposition (4.4) ved at flytte den mod støttekanalen (1), og monter dem med plastiksruer (2). (4.5)

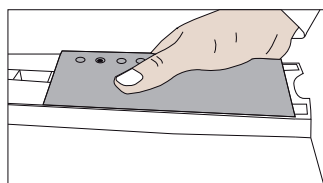
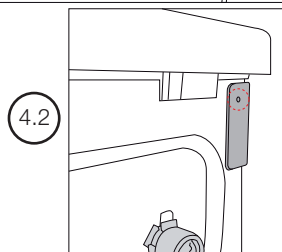
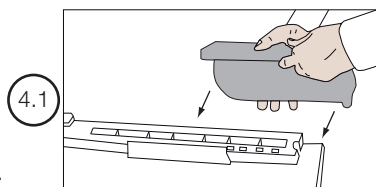

4.3

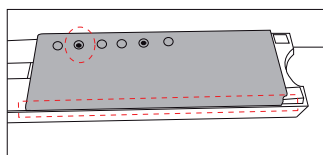

4.4

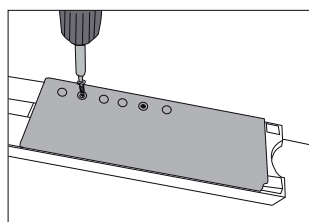

4.5

TRIN 5 :

For at fastgøre støttekanalen (1a-1b) til vaskemaskinens kabinet,

- Som vist i figur 5.1, bruge selvskærende skrue (5a), der leveres med Stableudstyr-sættet, med henblik på at positionere (3a) delen på vaskemaskinens kabinet og lave en forbindelse.

⚠ For tilslutningen i dette trin anvendes **kun den specielt designede skrue nr. 5a og 1 styk bruges til** installationen. (5.1)

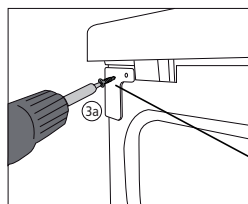

5.1

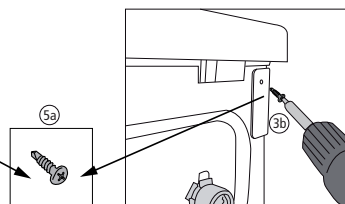

5.2

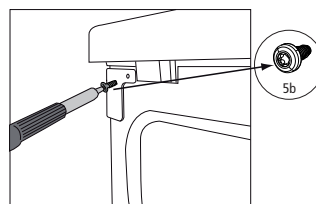

5.3

- Som vist i figur 5.2, bruge selvskærende skrue (5a), der leveres med Stableudstyr-sættet, med henblik på at positionere (3b) delen på vaskemaskinens kabinet og lave en forbindelse.

⚠ For tilslutningen i dette trin anvendes kun den **specielt designede skrue nr. 5a og 1 stykker bruges til** installationen. (5.2)

⚠ Hvis der er et installeringshul i kabinettet; brug butt-end torx skrue (5b) i stedet for drill-bit selvskærende skrue (5a). (5.3)

TRIN 6 :

For at anbringe tørretumbleren oven på vaskemaskinen ved brug af stableudstyr;

 Åbn først de 4 justerbare føder på tørretumbleren ved at dreje dem i 4-6 omgange. (6.1)

- Løft tørretumbleren (der skal mindst to personer til dette), og anbring den på støttekanalen (1). (6.2)

 Kontrollér tørretumblerens stabilitet efter du har åbnet fødderne.

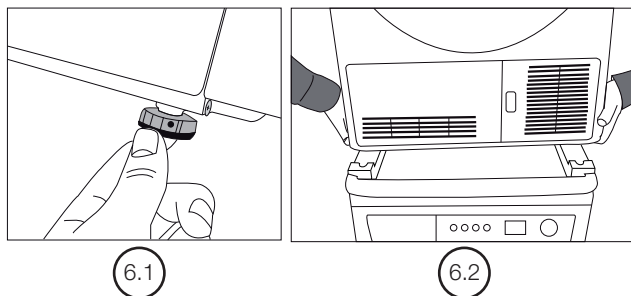

TRIN 7 :

Flyt tørretumbleren frem på støttekanaler (1). (7.1)

Fortsat med at glide maskinen, indtil fødderne er placeret og sikret på kanalen over støttekanalen (1). (7.2)

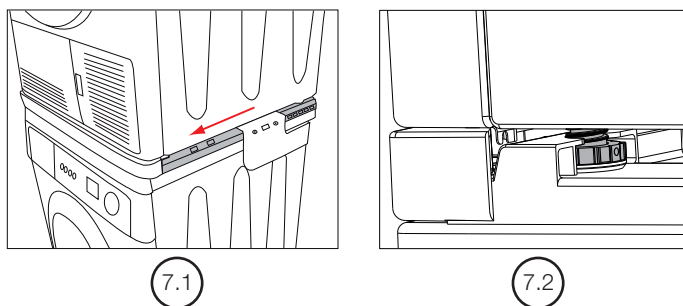

TRIN 8 :

Fjern skrueerne fra bagsiden af tørretumbleren, som vist i figuren, fra den venstre og højre side. Disse skrue skal bruges senere. (8.1)

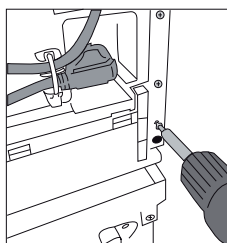

TRIN 9 :

Til tilslutning af tørretumbler og stableudstyret;

- Løft tørretumbleren ved at skubbe den frem fra bagsiden. Installer den bagerste fastgørelsesdel (4) på støttekanalen (1). (9.1)

⚠ Der er to typer af de bagerste støttedeile (4a-4b): venstre og højre. Det er ikke muligt at installere i den omvendte retning, fordi de bagerste fastgørelsesdele er lavet som venstre og højre del. (4a-4b)

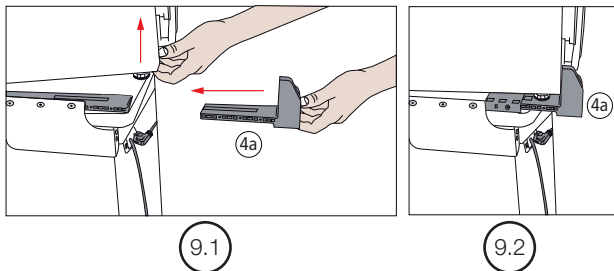

TRIN 10 :

Flyt de bagerste fastgørelsesdele (4a-4b) inde i støttekanalen (1a-1b) efter dybden af tørretumbleren.

- Efter justeringen skal du bruge de skruer, der blev fjernet trin 8, til at fastgøre de bagerste støttedeile til tørretumblerens kabinet. (10.1)

⚠ Brug kun el-skruetrækker til at skrue skruer.

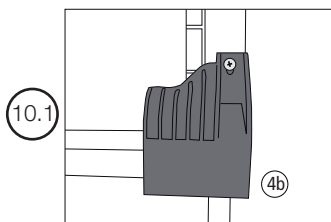

TRIN 11 :

For at fuldføre samling af vaskemaskine og tørretumbler ved hjælp af Stableudstyr;

- Match de tilsvarende huller mellem dele nr. 1 og 3, og forbind disse huller (2) ved hjælp af plastiksruer. (11.1)

- Afslut installation af Stableudstyr ved at udføre denne handling på begge sider.

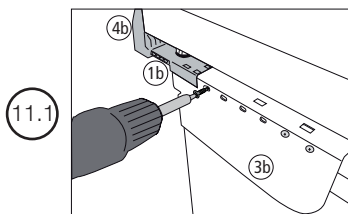

SUOMI

Osanro.	Osan nimi	Osanro.	Osan nimi	Osanro.	Osan nimi
1	Kiinnitystasot	3	Takaosan tukikannatin	5	a - Itsekiertyvät ruuvit b - Kupukantaiset torx-ruuvit
2	Ruuvit	4	Takaosan kiinnike	6	Peitelevy

VAIHE 1 :

Kiinnitä pakkauksen mukana tulleet muoviset kiinnikeosat (1a-1b) pesukoneeseen (PK) kuvan osoittamalla tavalla. (1.1)

Vihje : Kuvan epätasaiset pinnat tulee asettaa toisiaan vasten.

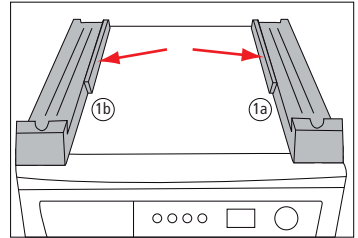

1.1

VAIHE 2 :

Sijoita välisarjan peitelevy (6) etupuoalle kuvan osoittamalla tavalla. (2.1)

Käytä tämän jälkeen "pakkauksen mukana tullutta 4 muoviruuvia" liittääksesi välisarjan peitelevyn (6) kiinni vasempaan ja oikeaan kiinnitystasoon (1). (2.2)

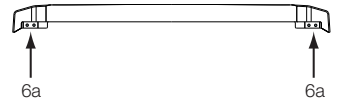

Vihje : Käytä ruuvinväännintä tämän toimenpiteen suorittamiseksi.

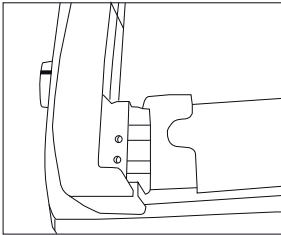

2.1

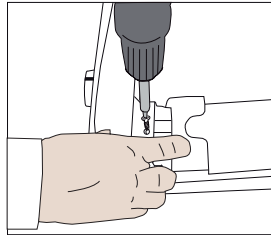

2.2

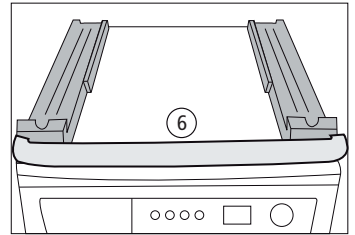

2.3

VAIHE 3 :

Aseta peitelevy (6) oikeaan asentoonsa PK:n ylätasoa kanssa. (3.1 - 3.2)

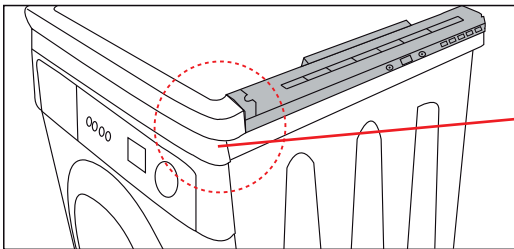

3.1

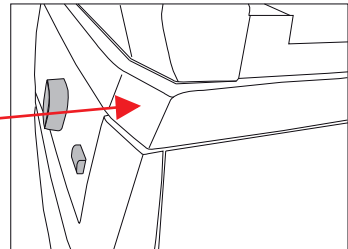

3.2

VAIHE 4 :

Aseta takaosan tukilevy (3) paikalleen ;

- kiinnitystasoon (1) kuvan 4.1 osoittamalla tavalla ensin. (4.1)
- aseta tämän jälkeen PK:n rungon reiät niin että ne tulevat vastakkain tukilevyn kanssa. (4.2)

Vihje 1 : Varmista että takaosan tukilevy on oikein kiinnitetty kiinnitystasoon kuvan 4.3 osoittamalla tavalla.

Vihje 2 : Kohdista ruuveja varten olevat reiät (4.4) vastakkain liikuttamalla takaosan tukilevyä kiinnitystason päällä (1) ja liitä ne yhteen käyttäen muoviruuveja (2). (4.5)

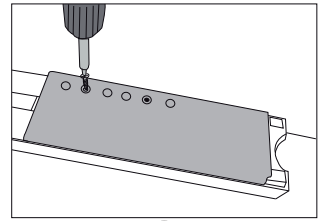
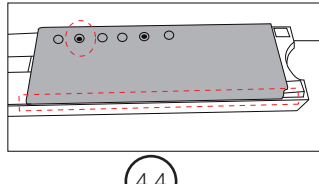
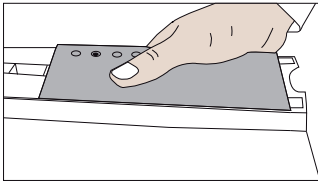
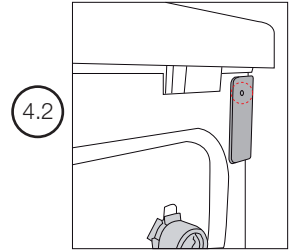
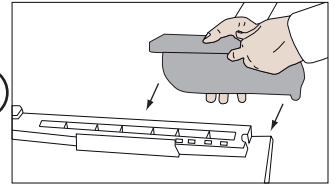

VAIHE 4 :

Liittääksesi kiinnitystason (1a-1b) PK:n runkoon,

- **Kuvan 5.1 osoittamalla tavalla**, käytä välisarjan mukana tullutta itsekiertyvää ruuvia (5a), aseta osa (3a) PK:n runkoa vasten ja kiinnitä se.

⚠ Suorittaaksesi tämän vaiheen, tarvitset **1 kpl** erikoisruuvia nro. 5a asennusta varten. (5.1)

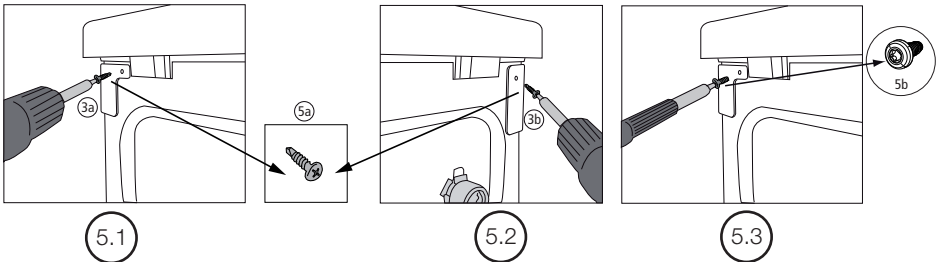

- Käytä välisarjan mukana toimitettua itsekiertyvää ruuvia (5a), aseta osa (3b) PK:n runkoa vasten kuvan 5.2 osoittamalla tavalla ja kiinnitä se.

⚠ Suorittaaksesi tämän vaiheen, tarvitset **1 kpl** erikoisruuvia nro. 5a asennusta varten. (5.2)

⚠ Jos koneen rungossa on reikä välisarjan asennusta varten; käytä pulltipäistä torx-ruuvia (5b) itsekiertyvän teräväkärkisen ruuvin (5a) sijaan. (5.3)

VAIHE 6 :

Asentaaksesi kuivausrummun (KR) pesukoneen (PK) ja välisarjan päälle tee seuraavasti;

- ⚠️ Avaa ensin kuivausrummun (KR) säädettävät jalat (4 kpl) kiertämällä niitä auki 4-6 kierroksen verran. (6.1)
- Nosta kuivausrumpu (KR) käyttäen vähintään kahta henkilöä, ja aseta se kiinnitystason päälle (1). (6.2)
- ⚠️ Varmista KR:n jalkojen vakaus säädön jälkeen.

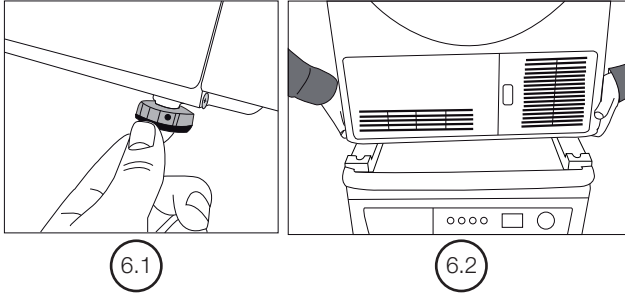

VAIHE 7 :

Työnnä kuivausrumpua (KV) eteenpäin kiinnitystasojen päällä (1). (7.1)

Jatka rummun liu'uttamista kunnes sen jalat ovat paikoillaan ja kiinnittyneet lujasti kiinnitystason tason päällä. (7.2)

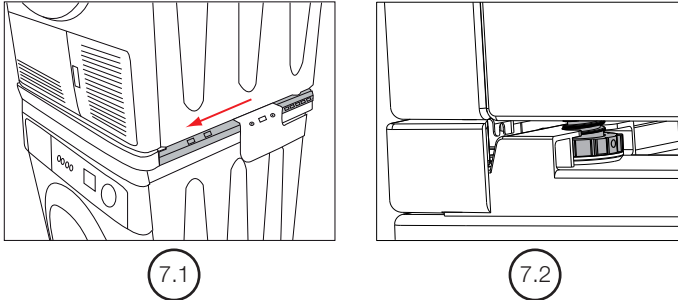

VAIHE 8 :

Poista PT-ruuvit KR:n rungon takaosasta kuvan osoittamalla tavalla sekä vasemmalta että oikealta puolelta. Nämä ruuvit ovat tarpeellisia myöhemmässä vaiheessa. (8.1)

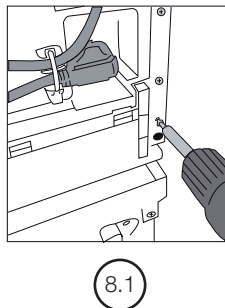

VAIHE 9 :

Liittääksesi KR:n ja välisarjan yhteen;

- Nosta KR työntämällä sitä eteenpäin rummun takaosasta. Kiinnitä takaosan kiinnikkeet (4) kiinnitystasoon (1). (9.1)



Takaosan kiinnikkeitä (4a-4b) on kaksi erilaista: vasemmalle ja oikealle tuleva kiinnike.

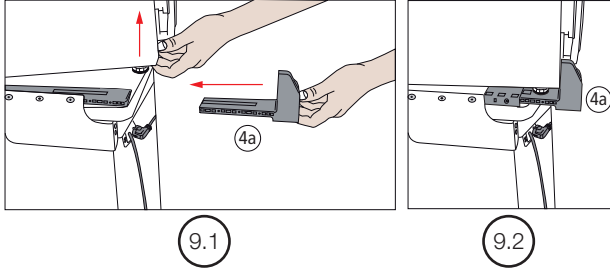

VAIHE 10 :

Työnnä takaosan kiinnikkeet (4a-4b) kiinnitystason (1a-1b) sisään KR:n leveyttä vastaavan määrän verran.

- Käytä tämän jälkeen ruuveja jotka irrotit vaiheessa 8 kiinnittääksesi takaosan kiinnikkeet KR:n runkoon. (10.1)



Käytä ruuvinväännintä vain ruuviliitoksen aikana.

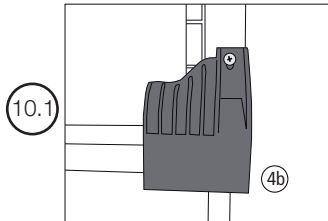

VAIHE 11 :

Viimeistelläksesi PK:n, KR:n ja välisarjan asennuksen;

- Aseta osien nro. 1 ja 3 reiät (2) vastakkain ja liitä ne yhteen käyttäen muoviruuveja. (11.1)

- Viimeistele välisarjan asennus tekemällä näin molemmin puolin.

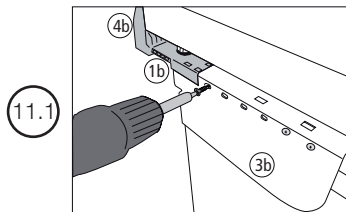

NORSK

Del Nr	Del Navn	Del Nr	Del Navn	Del Nr	Del Navn
1	Fastholdelseskanaler	3	Bagerste Støtte Tilslutningsdel	5	a - Selvskærende Skrue b - Stump-ende Torx skrue
2	Skruer	4	Bagerste Monteringsselement	6	Kosmetisk udseende Del

TRIN 1 :

Placer plastik fastholdelses (1a-1b) dele leveret i boksen på Vaskemaskine (WM), som vist i figuren. (1.1)

Tip : Geometriske overflader på figuren skal stå over hinanden.

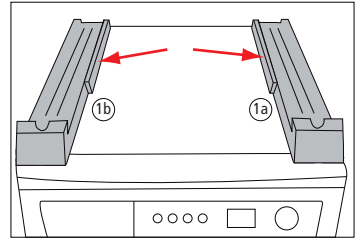

1.1

TRIN 2 :

Placer kosmetiske udseende del (6) på forsiden, som vist i figuren. (2.1)

Brug derefter "til plast skrue i kassen" for at udføre tilslutningen af udseende del (6) til venstre og højre fastholdelseskanaler (1). (2.2)



Tip : Brug strømforsynet skruetrækker til denne handling.

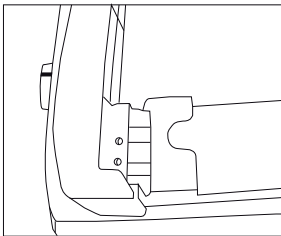

2.1

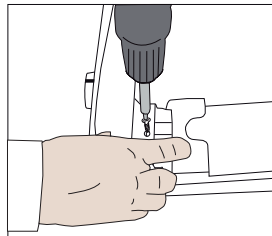

2.2

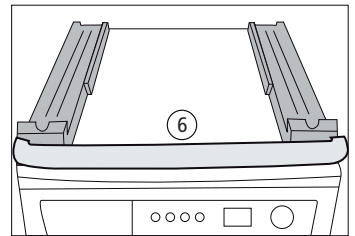

2.3

TRIN 3 :

Juster kosmetiske udseende del (6) til kosmetisk korrekte position med vaskemaskinens øverste bakke. (3.1 - 3.2)

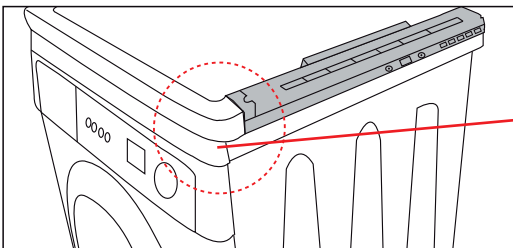

3.1

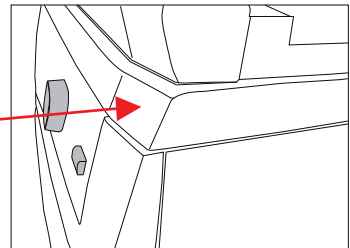

3.2

TRIN 4 :

Placer den bageste support plade (3) ;

- på fastholdelse kanal (1) som vist i figur 4.1, først. (4.1)
- Juster derefter hulpositionerne på vaskemaskinen. (4.2)

Tip 1 : Som vist i figur 4.3, sikre, at den sidder korrekt på vist kanal.

Tip 2 : Find den rigtige skrue position (4.4) ved at bevæge den på fastholdelse kanal (1), og monter dem med plastiskruer (2). (4.5)

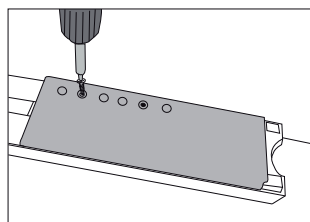
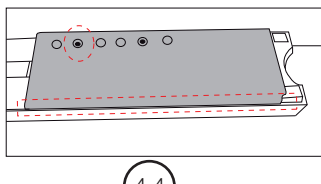
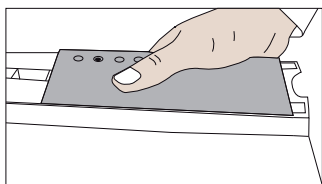
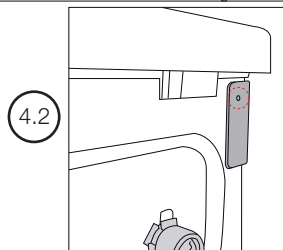
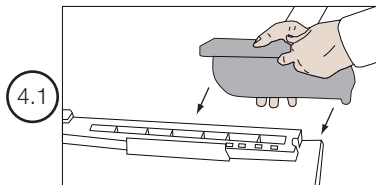

TRIN 5 :

For at skabe den holdende kanale (1a-1b) til vaskemaskine forbindelse,

- Som det fremgår af figur 5.1, skal du bruge selvskærende skrue (5a) leveret med Stabelkit samlingen, for at positionere (3a) del på vaskemaskinen og udføre forbindelsen.

⚠ For tilslutning i dette TRIN, special design nr. 5a skrue anvendes, og **1 bruges til** installationen. (5.1)

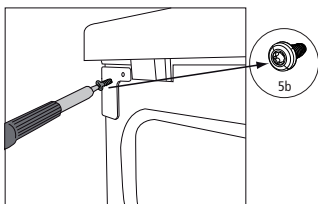
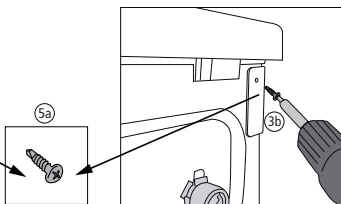
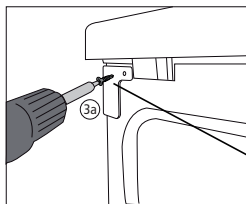

- Som det fremgår af figur 5.2, skal du bruge selvskærende skrue (5a) leveret med Stabelkit samlingen, for at positionere (3b) del på vaskemaskinen og udføre forbindelsen.

⚠ For tilslutning i dette TRIN, special design nr. 5a skrue anvendes, og **1 bruges til** installationen. (5.2)

⚠ Hvis der er et installations hul; Brug den stump-ende torx skrue (5b) i stedet for bore-bit selvskærende skrue (5a). (5.3)

TRIN 6 :

For at placere Tørretumbler (TT) på Vaskemaskine (VM) og Stabelkit samling;

! For det første åbne 4 justerbare fødderne af tørretumbler (TT) ved at dreje dem i 4-6 omgange. (6.1)

- Løft tørretumbler (TT) med mindst to personer, og placer den på fastholdeskanalen (1). (6.2)

! Kontrollere stabiliteten af Tørretumbler efter åbning af fødderne.

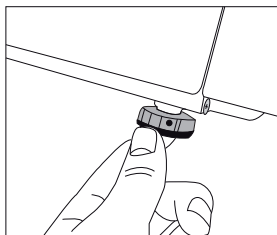

6.1

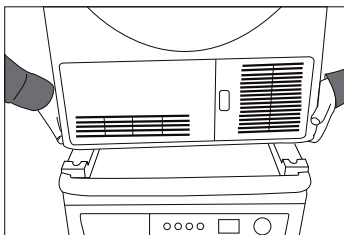

6.2

TRIN 7 :

Flyt tørretumbler (TT) fremad på at fastholdeskanalerne (1). (7.1)

Fortsæt med at skubbe maskinen, indtil fødderne er placeret og fastgjort på kanalen over fastholdelseskanalerne (1). (7.2)

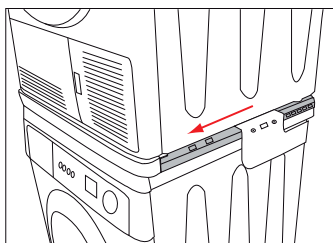

7.1

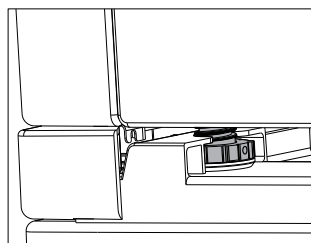

7.2

TRIN 8 :

Fjern PT skruer fra bagsiden af tørretumbler, som vist i figuren fra venstre og højre side. Disse skruer skal bruges senere. (8.1)

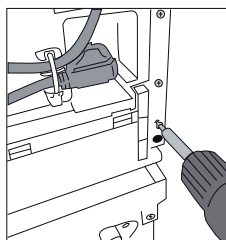

8.1

TRIN 9 :

For tilslutning af Tørretumbler og Stabelkit samling;

- Løft tørretumbleren ved at skubbe den fremad fra det bageste område. Installer den bageste fastsættelse del (4) til at fastholdelseskanal (1) delen. (9.1)

⚠ Bagerste fastholdelsesdele (4a-4b) har to typer: venstre og højre. Installation i den modsatte retning er ikke mulig. Fordi bageste fastgørelseselementer er udformet som venstre og højre.

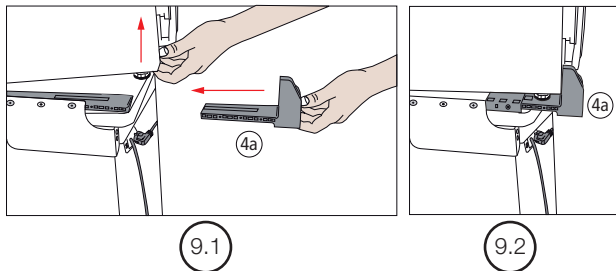

TRIN 10 :

Flyt bageste fastgørelseselementer (4a-4b) inde i fastholdelseskanalen (1a-1b) pr dybden på tørretumbleren.

- Efter denne justering, skal du bruge fjernede skruer fra TRIN 8 til at fastgøre bagerste støttelede til tørretumbleren. (10.1)

⚠ Brug strømforsynet skruetrækker til denne handling.

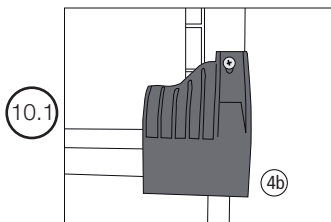

TRIN 11 :

For at fuldføre samling og tilslutninger af vaskemaskine, tørretumbler, og Stabelkit;

- Match de tilsvarende huller mellem dele nr. 1 og 3, og forbind disse matchende huller (2) med plast skruer. (11.1)

- Fuldfør Stabelkit installation ved at udføre denne operation i begge retninger.

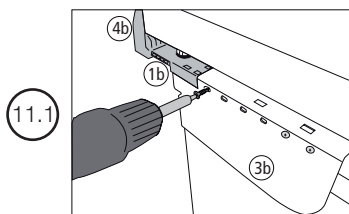

SVENSKA

Delnr.	Artikelnamn	Delnr.	Artikelnamn	Delnr.	Artikelnamn
1	Kvarhållande skenor	3	Bakre stödanslutningsdel	5	a - Självfästande skruvar b - Nyckelskruv
2	Skruvar	4	Bakre fästelement	6	Paneldel

STEG 1 :

Placera de kvarhållande plasticskenorna (1a - 1b) som levereras i boxen, på tvättmaskinen, så som visas på bilden. (1.1)

Tips : Geometriska ytor på bilden ska vara mot varandra.

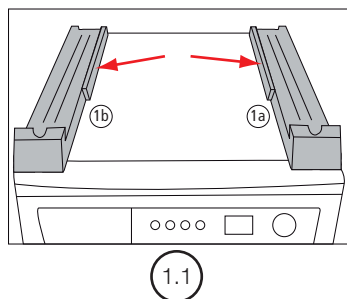

STEG 2 :

Placera den paneldelen (6) på fronten så som visas på bilden. (2.1)

Använd sedan plasticskruvarna som är avsedda för anslutningen (6) vid de vänstra och högra kvarhållande skenor (1). (2.2)

Tips : Använd en skruvdragare för det här förfarandet.

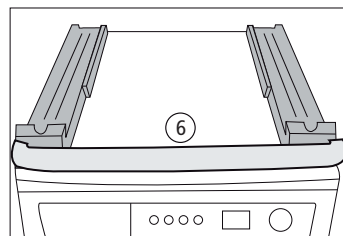
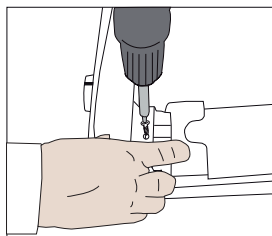
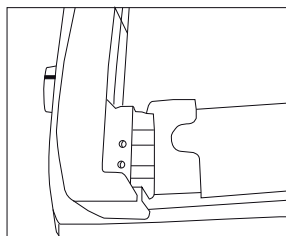
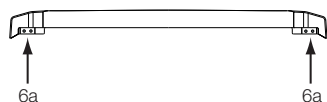

STEG 3 :

Justera paneldelen (6) i enlighet med tvättmaskinens övre bricka. (3.1 - 3.2)

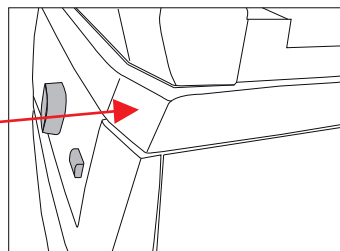
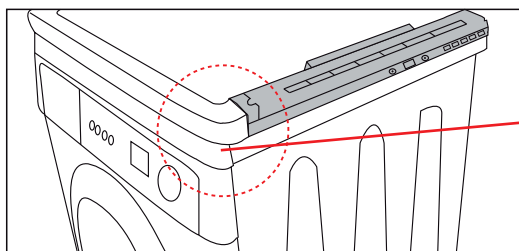

STEG 4 :

Placera den **bakre stödplattan** (3);

- på den kvarhållande skenan (1) så som visas i bild 4.1 först. (4.1)

- Justera sedan hållpositionerna på tvättmaskinen. (4.2)

Tips 1 : Säkerställ att den sitter fast ordentligt liksom i bild 4.3.

Tips 2 : Hitta rätt skruvposition (4.4) genom att flytta den till kvarhållande skenan (1) och montera den med plastskruvar (2). (4.5)

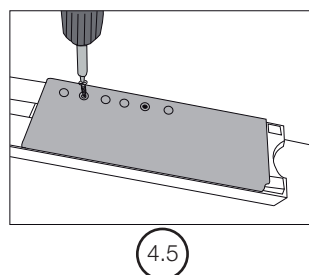
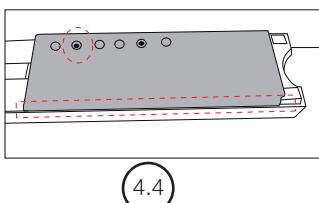
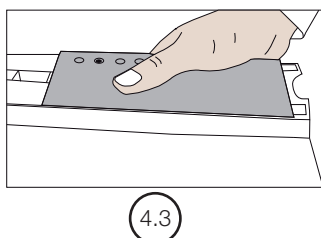
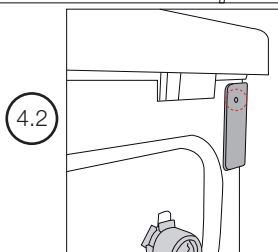
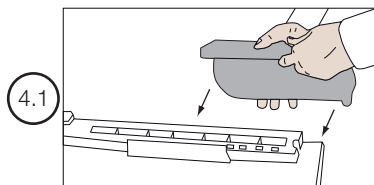

STEG 5 :

För att ansluta den **kvarhållande skenan** (1a-1b) med maskinanslutningen,

- Så som visas i **bild 5.1**, använd självfästande skruvar (5a) som kommer med monteringspaketet, för att placera (3a) delen på tvättmaskinen och utför anslutningen.

⚠ För anslutningen i den här steget används endast 5a-skruven, som är särskilt utformad och **1 del används för** installationen. (5.1)

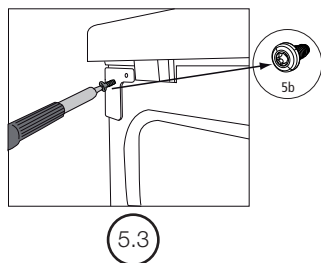
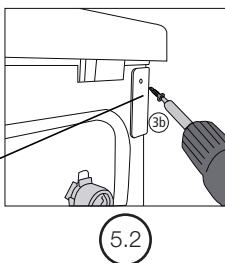
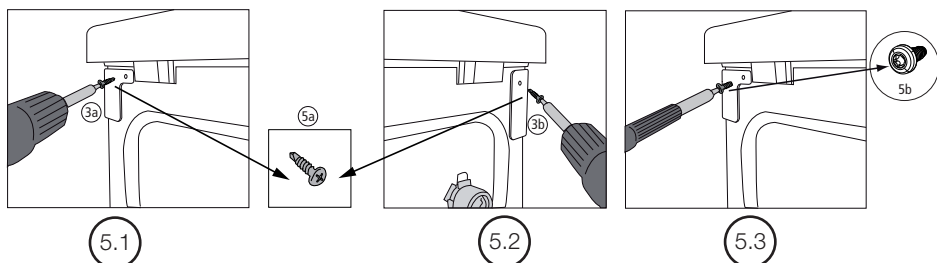

- Så som visas i **bild 5.2**, använd självfästande skruvar (5a) som kommer med monteringspaketet, för att placera (3b) delen på tvättmaskinen och utför anslutningen.

⚠ För anslutningen i den här steget används endast 5a-skruven, som är särskilt utformad och **1 del används för** installationen. (5.2)

⚠ Om det finns installationshål på maskinen; använd nyckelskruvarna (5b) istället för att borra för nyckelskruvarna (5a). (5.3)

STEG 6 :

För att placera torken på tvättmaskinen och stapelpaketets montering;

! Justera först de justerbara fötterna på torken, genom att rotera dem 4-6 gånger. (6.1)

- Lyft torken, var minst två personer och placera den på den kvarhållande skenan (1). (6.2)

! Kontrollera torkens stabilitet efter att du öppnat fötterna.

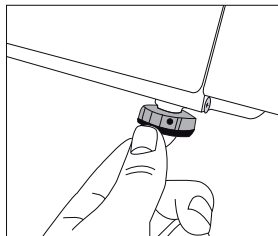

6.1

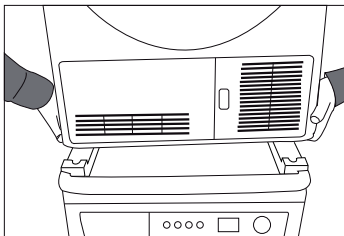

6.2

STEG 7 :

Flytta på torken fram mot den kvarhållande skenan (1). (7.1)

Fortsätt låta maskinen glida tills dess fötterna är placerade och säkrade på anslutningen över fästet (1). (7.2)

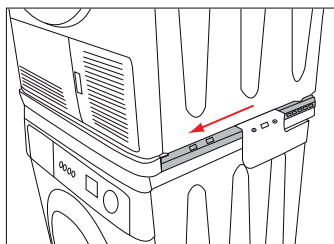

7.1

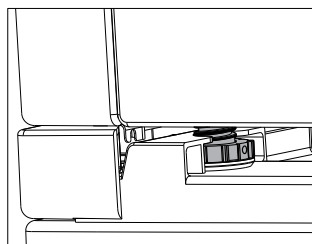

7.2

STEG 8 :

Ta bort PT-skruvorna ifrån den bakre delen av torken, så som visas i figuren, ifrån vänster till höger. Skruvarna ska användas senare. (8.1)

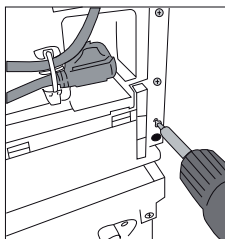

8.1

STEG 9 :

För anslutning av torken och stapelpaketets montering;

- Lyft torken genom att trycka den lite framåt ifrån bakre delen. Installera de fästande delarna (4) till den kvarhållande (1) skenan. (9.1)

! De bakre kvarhållande delarna (4a-4b) kommer i två olika sorter: vänster och höger. Installation i motsatt riktning är inte möjlig. Eftersom de bakre fästena är utformade som höger och vänster.

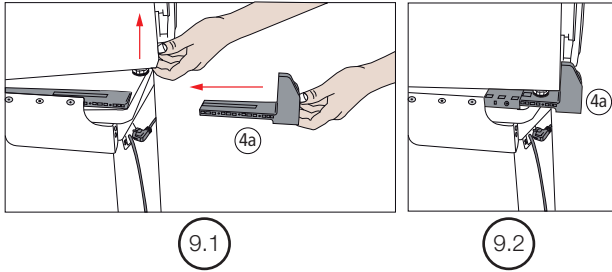

STEG 10 :

Flytta de bakre fästena (4a-4b) i den kvarhållande skenan (1a-1b) med samma mått som torken.

- Efter denna justering kan du använda skrivarna som togs bort i steg 8, för att säkra de kvarhållande delarna till torkmaskinen. (10.1)

! Använd endast skruvdragare vid skruvning.

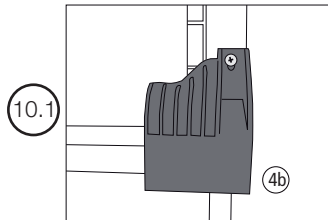

STEG 11 :

För att genomföra tvättmaskinens och torkens stapelpaketsanslutningar;

- Matcha motsvarande hål mellan del 1 och 3 och anslut dessa matchande hål (2) med plastskruvarna. (11.1)

- Slutför stapelpaketetsinstallationen genom att utföra förfarandet i båda riktningarna.

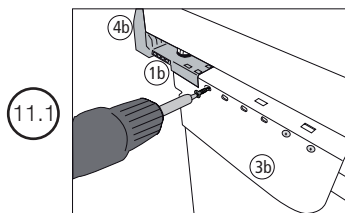

ESPAÑOL

N.º de pieza	Nombre de pieza	N.º de pieza	Nombre de pieza	N.º de pieza	Nombre de pieza
1	Conductos de retención	3	Pieza de soporte de conexión trasera	5	a - Tornillos autorroscantes b - Tornillo de cabeza Torx
2	Tornillos	4	Elemento trasero de fijación	6	Pieza embellecedora

PASO 1:

Coloque las piezas de retención de plástico (1a-1b) que encontrará en la caja de la lavadora (WM) tal como se muestra en la figura. (1.1)

Sugerencia: Las superficies geométricas que se muestran en la figura deben estar encaradas.

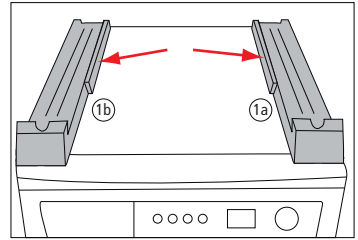

1.1

PASO 2:

Coloque la pieza embellecedora (6) en la parte delantera de la lavadora, tal como se muestra en la figura. (2.1)

A continuación, utilice los cuatro tornillos de plástico que encontrará en la caja para fijar la pieza embellecedora (6) a los conductos de retención derecho e izquierdo (1). (2.2)

Sugerencia: Use un destornillador eléctrico para esta operación.

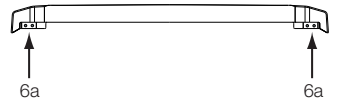

6a

6a

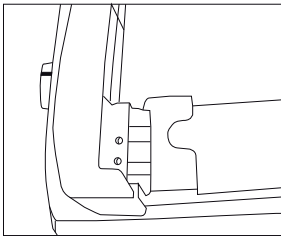

2.1

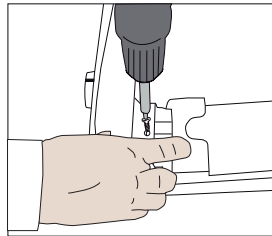

2.2

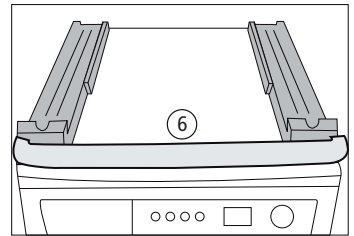

2.3

PASO 3:

Alinee la pieza embellecedora (6) con la bandeja superior de la lavadora en una posición estéticamente adecuada. (3.1 - 3.2)

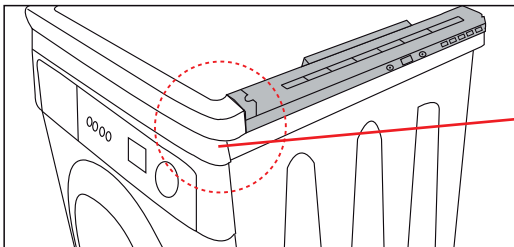

3.1

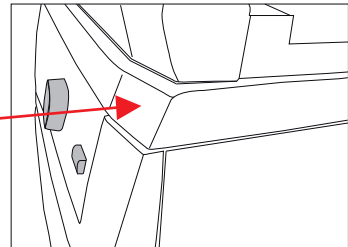

3.2

PASO 4:

Coloque la placa de soporte trasera (3);

- En primer lugar en el conducto de retención (1), tal como se muestra en la figura 4.1. (4.1)

- A continuación ajuste las posiciones de los orificios en el cuerpo de la lavadora. (4.2)

Sugerencia 1 : Asegúrese de que esté bien asentada sobre el conducto, tal como se muestra en la figura 4.3.

Sugerencia 2 : Busque un posición adecuada para los tornillos (4.4) desplazando la placa sobre el conducto de retención (1), y fijela con los tornillos de plástico (2). (4.5)

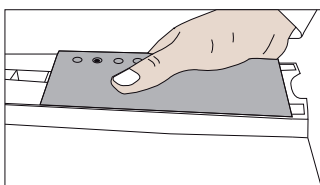

4.3

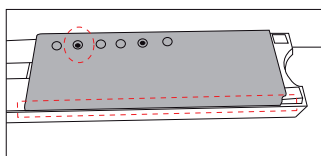

4.4

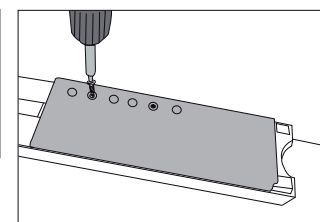

4.5

PASO 5:

Para conectar el conducto de retención (1a-1b) al cuerpo de la lavadora,

- Utilice el tornillo autorroscante (5a) que encontrará en el kit de apilado para colocar la pieza (3a) sobre el cuerpo de la lavadora, **tal como se muestra en la figura 5.1**, y realice la conexión.

⚠ Para la conexión en este paso, **utilice únicamente un tornillo de diseño especial n.º 5a.** (5.1)

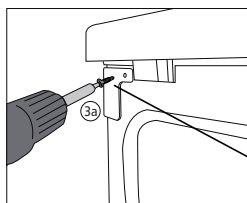

5.1

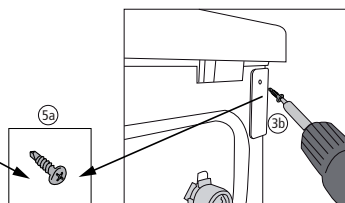

5.2

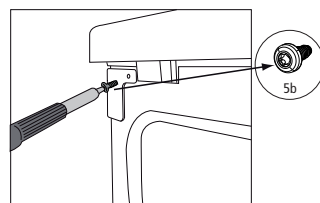

5.3

- Utilice el tornillo autorroscante (5a) que encontrará en el kit de apilado para colocar la pieza (3b) sobre el cuerpo de la lavadora, **tal como se muestra en la figura 5.2**, y realice la conexión.

⚠ Para la conexión en este paso, **utilice únicamente un tornillo de diseño especial n.º 5a.** (5.2)

⚠ Si hay un orificio de instalación en el cuerpo, use un tornillo de tope Torx (5b) en vez de tornillo autorroscante de broca (5a). (5.3)

PASO 6:

Para colocar la secadora (TD) sobre la lavadora (WM) y el kit de apilado;

 Primero abra los 4 pies ajustables de la secadora (TD) girándolos entre 4 y 6 vueltas. (6.1)

- Eleve la secadora (TD) entre dos personas, y colóquela sobre el conducto de retención (1). (6.2)

 Compruebe la estabilidad de la secadora tras abrir los pies.

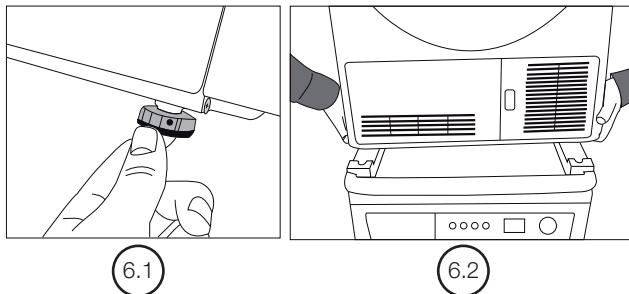

PASO 7:

Mueva la secadora (TD) hacia adelante sobre los conductos de retención (1). (7.1)

Siga deslizando la máquina hasta que los pies queden firmemente colocados en el conducto sobre el conducto de retención (1). (7.2)

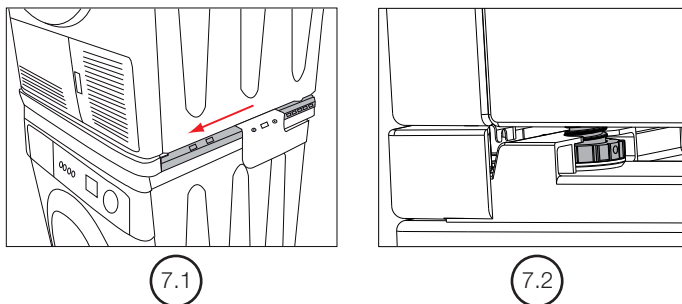

PASO 8:

Quite los tornillos PT de la parte trasera de la secadora, tal como muestra la figura, a derecha e izquierda. Utilizará estos tornillos más adelante. (8.1)

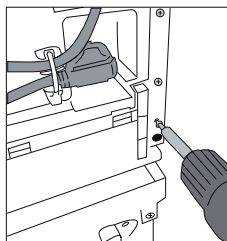

8.1

PASO 9:

Para conectar la secadora y el kit de apilado:

- Eleve la secadora empujándola hacia adelante desde la parte trasera. Instale la pieza de fijación trasera (4) en la pieza del conducto de retención (1). (9.1)

! Hay dos tipos de piezas de retención traseras (4a-4b): izquierda y derecha. La instalación en la dirección contraria es imposible, ya que las piezas de fijación trasera están diseñadas específicamente para la izquierda y la derecha. (4a-4b)

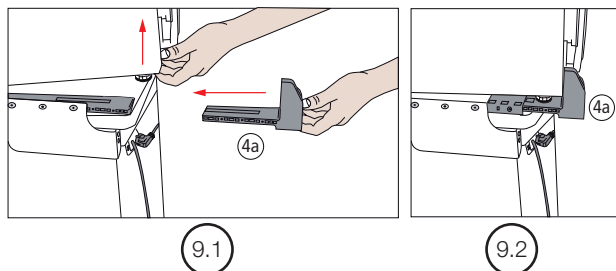

PASO 10:

Desplace las piezas de fijación traseras (4a-4b) hacia el interior del conducto de retención (1a-1b) según la profundidad de la secadora.

- Una vez realizado este ajuste, use los tornillos que retiró en el paso 8 para fijar las piezas de retención traseras al cuerpo de la secadora. (10.1)

! Utilice destornilladores eléctricos solo durante la colocación de los tornillos.

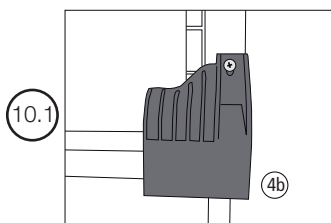

PASO 11:

Para completar las conexiones de la lavadora, la secadora y el kit de apilado:

- Empareje los orificios correspondientes de las piezas n.º 1 y 3, y conecte estos orificios emparejados (2) mediante tornillos de plástico. (11.1)

- Complete la instalación del kit de apilado realizando esta operación en ambas direcciones.

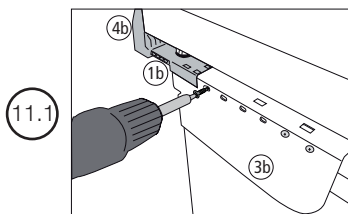

PORTUGUÊS

Parte nº	Nome da parte	Parte nº	Nome da parte	Parte nº	Nome da parte
1	Canais de retenção	3	Parte de ligação do suporte traseiro	5	a - Parafusos auto-roscentes b - Parafuso Torx de ponta grossa
2	Parafusos	4	Elemento de fixação traseiro	6	Parte de efeito estético

PASSO 1 :

Coloque as partes de retenção de plástico (1a-1b) fornecidas na caixa na máquina de lavar (ML), como exibido na figura. (1.1)

Dica : As superfícies geométricas na figura devem estar voltadas uma para a outra.

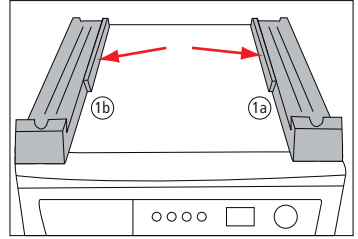

1.1

PASSO 2 :

Coloque a parte de efeito estético (6) no lado da frente, como exibido na figura. (2.1)

Em seguida, utilize os “quatro parafusos plásticos fornecidos na caixa” para realizar a ligação da parte de efeito estético (6) aos canais de retenção esquerdo e direito (1). (2.2)

Dica : Utilize uma chave de fendas eléctrica para esta operação.

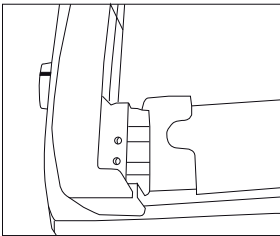
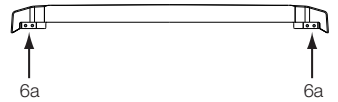

2.1

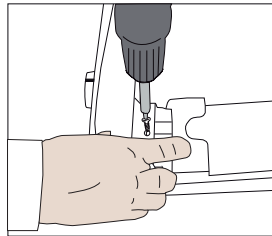

2.2

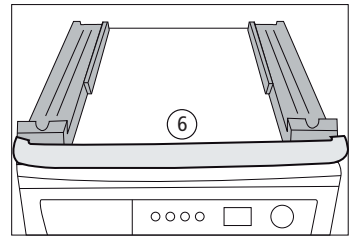

2.3

PASSO 3 :

Alinhe a peça de efeito estético (6) à posição esteticamente apropriada com o tabuleiro superior da ML. (3.1 - 3.2)

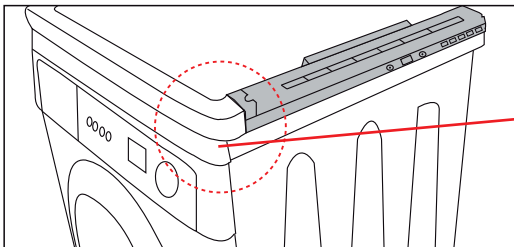

3.1

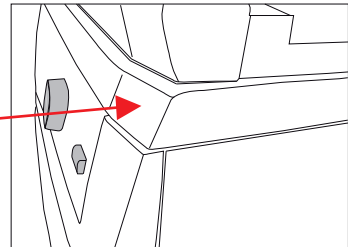

3.2

PASSO 4 :

Coloque a placa de suporte traseira (3) ;

- no canal de retenção (1), como exibido na figura 4.1 em primeiro lugar. (4.1)

- Depois ajuste as posições do orifício ao corpo da ML. (4.2)

Dica 1 : Como exibido na figura 4.3, verifique se está adequadamente encaixado no canal exibido.

Dica 2 : Procure a posição apropriada do parafuso (4.4) movendo-o no canal de retenção (1) e montando-os com o parafuso plástico (2). (4.5)

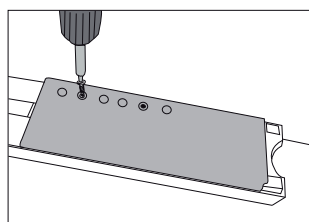
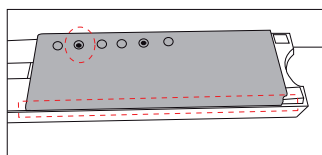
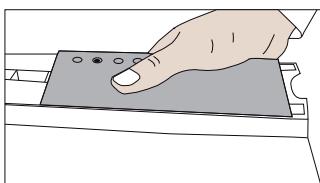
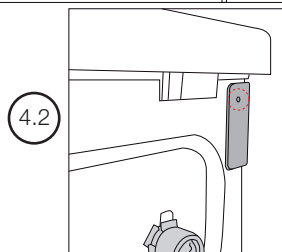
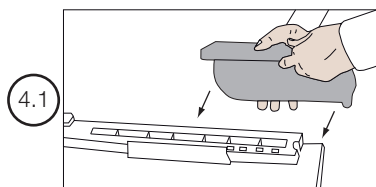

PASSO 5 :

Para fazer o canal de retenção (1a-1b) para ligação do corpo da ML,

- Como exibido na figura 5.1, utilize o parafuso auto-roscante (5a) entregue com o kit de empilhamento, de forma a posicionar a parte (3a) no corpo da ML e realizar a ligação.

⚠ Para a ligação neste passo, é utilizado apenas o parafuso nº 5a com desenho especial e 1 peça para a instalação. (5.1)

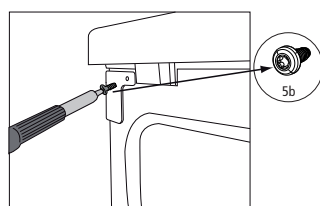
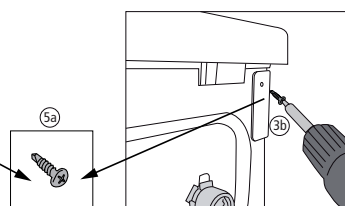
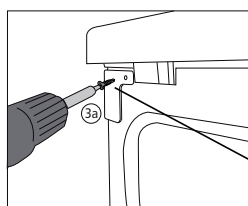

- Como exibido na figura 5.2, utilize o parafuso auto-roscante (5a) entregue com o kit de empilhamento, de forma a posicionar a parte (3b) no corpo da ML e realizar a ligação.

⚠ Para a ligação neste passo, é utilizado apenas o parafuso nº 5a com desenho especial e 1 peça para a instalação. (5.2)

⚠ Se houver um orifício de instalação na estrutura: utilize um parafuso torx de ponta grossa (5b) em vez do parafuso auto-roscante com ponta de broca (5a). (5.3)

PASSO 6 :

Para poder colocar o secador de Tambor (ST) na Máquina da Lavar (ML) e o kit de empilhamento;

 Primeiro abra os 4 pés ajustáveis do Secador de Tambor (ST) rodando-os 4-6 vezes. (6.1)

- Levante o Secador de Tambor (ST) com a ajuda de do mínimo duas pessoas e coloque-o no canal de retenção (1). (6.2)

 Verifique a estabilidade do ST após abrir os pés.

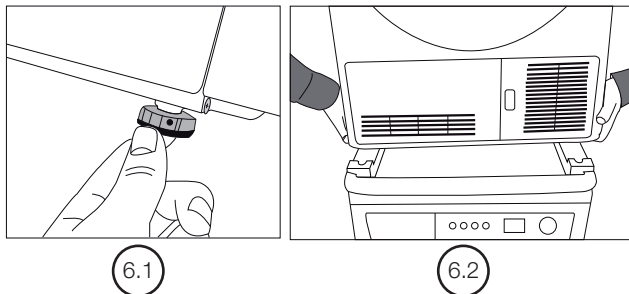

PASSO 7 :

Mova o Secador de Tambor (ST) para a frente nos canais de retenção (1). (7.1)

Continue a deslizar a máquina até os pés estarem posicionados e presos na guia sobre o canal de retenção (1). (7.2)

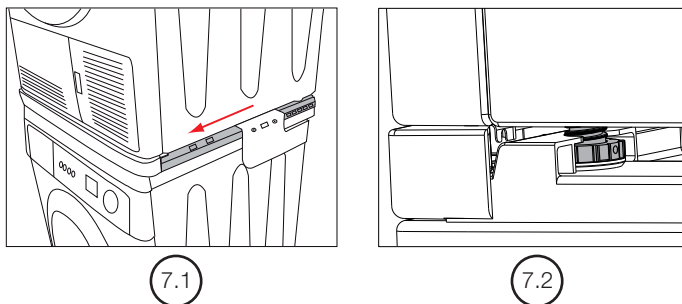

PASSO 8 :

Remova os parafusos do PT do corpo traseiro do ST como exibido na figura, da esquerda para a direita. Estes parafusos serão utilizados mais tarde. (8.1)

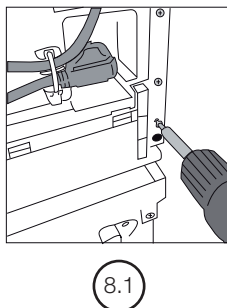

PASSO 9 :

Para a ligação do ST e do kit de empilhamento;

- Levante o ST empurrando-o para frente da área traseira. Instale a parte de fixação traseira (4) na parte do canal de retenção (1). (9.1)

 As partes de retenção traseira (4a-4b) são de dois tipos: esquerda e direita. Não é possível a instalação em direcção contrária, devido às partes de fixação traseira estarem concebidas como esquerda e direita. (4a-4b)

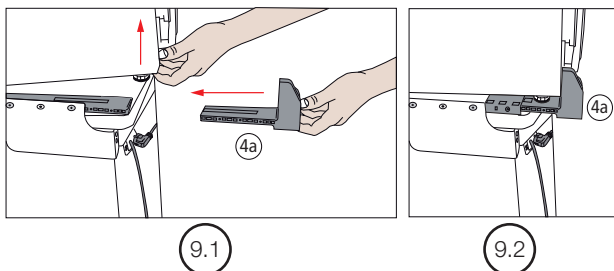

PASSO 10 :

Mova as partes de fixação traseiras (4a-4b) dentro do canal de retenção (1a-1b) conforme a profundidade do ST (Secador de Tambor).

- Após este ajuste, utilize os parafusos removidos no passo 8 para segurar as partes de retenção traseiras ao corpo do ST. (10.1)

 Utilize chaves de fenda eléctricas apenas durante a ligação do parafuso.

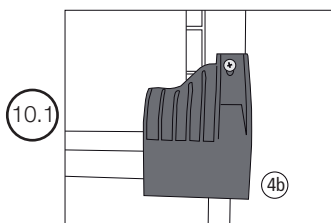

PASSO 11 :

Para finalizar as ligações de montagem da ML, do ST e do kit de empilhamento;

- Alinhe os orifícios correspondentes com as partes nº 1 e nº 3 e ligue estes orifícios correspondentes (2) com os parafusos plásticos. (11.1)

- Complete a instalação do kit de empilhamento realizando esta operação em ambas as direcções.

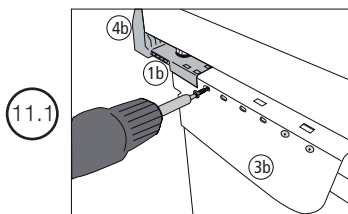

ITALIANO

Parte n.	Nome della parte	Parte n.	Nome della parte	Parte n.	Nome della parte
1	Condotti di tenuta	3	Parte di collegamento supporto posteriore	5	a - Viti autofilettanti b - Vite Torx con impugnatura inferiore
2	Viti	4	Elemento di fissaggio posteriore	6	Parte decorativa

FASE 1 :

Mettere le parti di tenuta in plastica (1a-1b) in dotazione nella scatola sulla lavatrice (WM) come mostrato nella figura. (1.1)

Suggerimento : Le superfici geometriche sulla figura devono essere rivolte una verso l'altra.

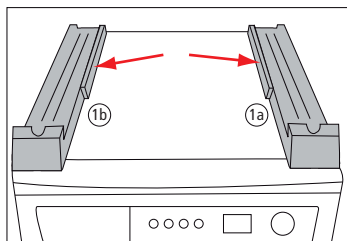

(1.1)

FASE 2 :

Mettere la parte decorativa (6) sulla parte anteriore come mostrato nella figura. (2.1)

Poi utilizzare le "viti per plastica in dotazione nella scatola" per eseguire il collegamento tra parte decorativa (6) e condotti di tenuta di sinistra e destra (1). (2.2)

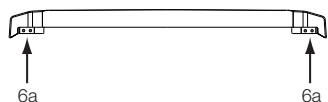

Suggerimento : Utilizzare un cacciavite elettrico per questa operazione.

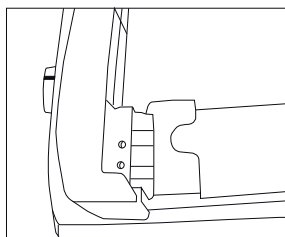

(2.1)

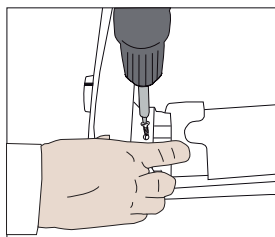

(2.2)

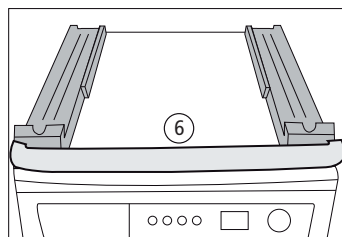

(2.3)

FASE 3 :

Allineare la parte decorativa (6) secondo la posizione corretta esteticamente con il vassoio superiore della lavatrice. (3.1 - 3.2)

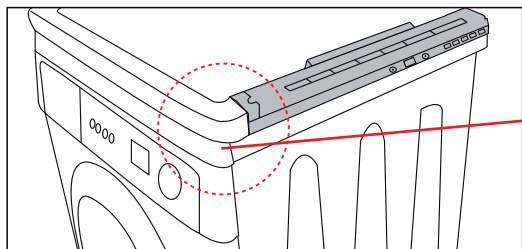

(3.1)

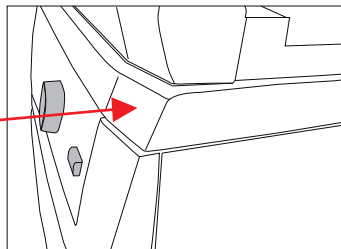

(3.2)

FASE 4 :

Montare la piastra di supporto posteriore (3) ;

- sul condotto di tenuta (1) come mostrato prima nella figura 4.1. (4.1)

- Poi regolare le posizioni dei fori sul corpo della lavatrice. (4.2)

Suggerimento 1 : Come mostrato nella figura 4.3, assicurarsi che la posizione sia corretta sul condotto mostrato.

Suggerimento 2 : Trovare la posizione corretta per la vite (4.4) spostandola sul condotto di tenuta (1) e montare con le viti in plastica (2). (4.5)

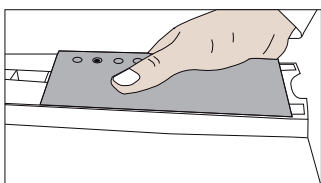

4.3

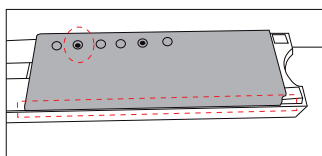

4.4

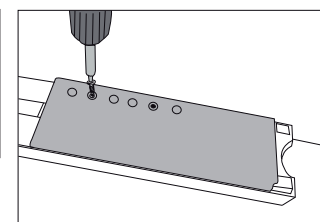

4.5

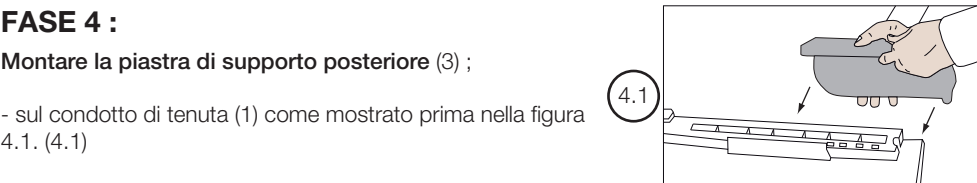

4.1

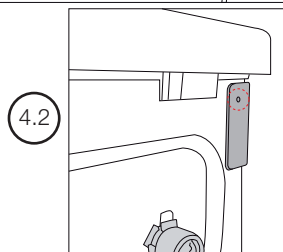

4.2

FASE 5 :

Al fine di eseguire il collegamento del condotto di tenuta (1a-1b) al corpo della lavatrice,

- Come mostrato nella figura 5.1, utilizzare la vite autofilettante (5a) in dotazione con il kit di assemblaggio per posizionare la parte (3a) sul corpo della lavatrice ed eseguire il collegamento.

⚠ Per il collegamento in questa fase, si usa solo la vite speciale n. 5a e 1 pezzo è utilizzato per l'installazione. (5.1)

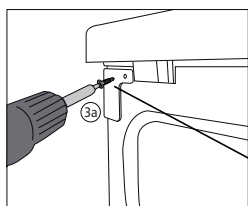

5.1

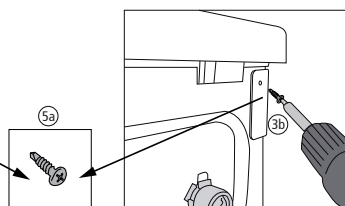

5.2

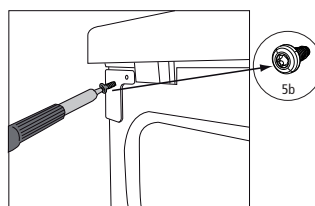

5.3

- Come mostrato nella figura 5.2, utilizzare la vite autofilettante (5a) in dotazione con il kit di assemblaggio per posizionare la parte (3b) sul corpo della lavatrice ed eseguire il collegamento.

⚠ Per il collegamento in questa fase, si usa solo la vite speciale n. 5a e 1 pezzi sono utilizzati per l'installazione. (5.2)

⚠ Se è presente un foro di installazione nel corpo, utilizzare una vite a impugnatura inferiore con punta a stella (5b) invece della vite autofilettante con punta a trapano (5a). (5.3)

FASE 6 :

Per posizionare l'asciugatrice (TD) sulla lavatrice (WM) e il kit di assemblaggio;

 Per prima cosa aprire i 4 piedini regolabili dell'asciugatrice (TD) ruotandoli per 4-6 giri. (6.1)

- Sollevare l'asciugatrice (TD) in almeno due persone e posizionarla sul condotto di tenuta (1). (6.2)

 Controllare la stabilità dell'asciugatrice dopo aver aperto i piedini.

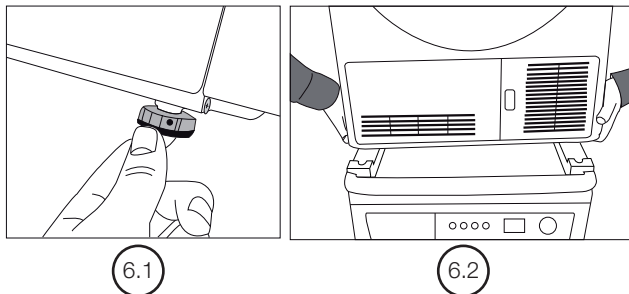

FASE 7 :

Spostare l'asciugatrice (TD) in avanti sui condotti di tenuta (1). (7.1)

Continuare a far scorrere l'elettrodomestico finché i piedini non sono posizionati e assicurati sul condotto al di sopra del condotto di tenuta (1). (7.2)

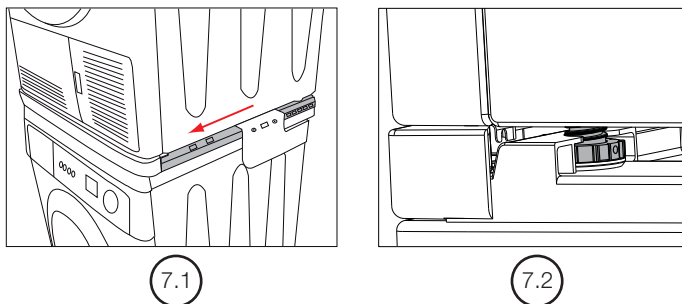

FASE 8 :

Rimuovere le viti in plastica dalla parte posteriore dell'asciugatrice come mostrato nella figura, dal lato sinistro e destro. Queste viti saranno utilizzate successivamente. (8.1)

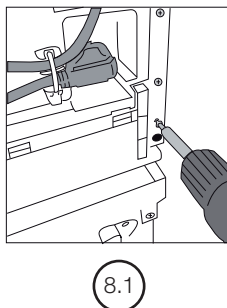

FASE 9 :

Per il collegamento di asciugatrice e kit di assemblaggio;

- Sollevare l'asciugatrice spingendola in avanti dall'area posteriore. Installare la parte di fissaggio posteriore (4) alla parte del condotto di tenuta (1). (9.1)

 Le parti di tenuta posteriori (4a-4b) sono di due tipo: di sinistra e destra. L'installazione nella direzione opposta non è possibile. Poiché le parti di fissaggio posteriore sono concepite per la sinistra e la destra. (4a-4b)

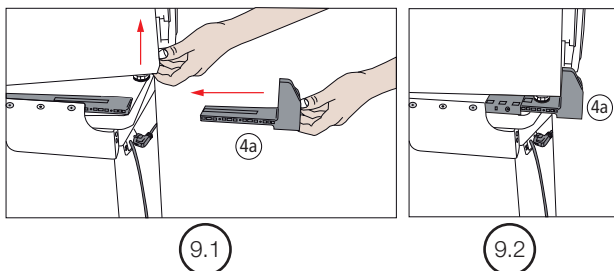

FASE 10 :

Spostare le parti per il fissaggio posteriore (4a-4b) all'interno del condotto di tenuta (1a-1b) secondo la profondità dell'asciugatrice.

- Dopo questa regolazione, utilizzare le viti rimosse alla fase 8 per assicurare le parti di tenuta posteriore al corpo dell'asciugatrice. (10.1)

 Utilizzare cacciaviti elettrici solo durante il collegamento delle viti.

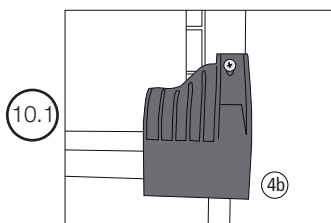

FASE 11 :

Per completare i collegamenti di lavatrice, asciugatrice e kit di assemblaggio;

- Far corrispondere i fori tra le parti n. 1 e 3 e collegare questi fori corrispondenti (2) con le viti in plastica. (11.1)

- Completare l'installazione del kit di assemblaggio eseguendo questa operazione in entrambe le direzioni.

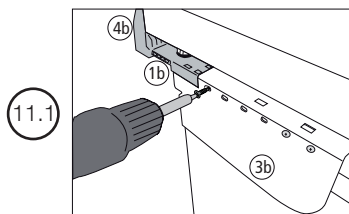

PO POLSKU

Nr części	Nazwa części	Nr części	Nazwa części	Nr części	Nazwa części
1	Prowadnice ustalające	3	Element łączący tylny wspornik	5	a - Śruby samogwintujące b - Śruba z łbem typu torx
2	Śruby	4	Tylny element mocujący	6	Element ozdobny

KROK 1 :

Umieść dostarczone w pudełce plastikowe elementy ustalające (1a - 1b) na pralce, jak pokazano na rysunku. (1.1)

Wskazówka : Powierzchnie geometryczne na rysunku powinny być skierowane ku sobie.

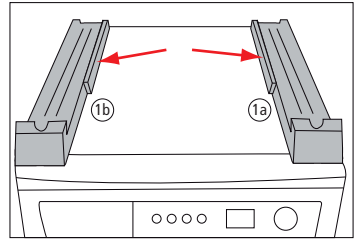

(1.1)

KROK 2 :

Umieścić element ozdobny (6) z przodu, jak pokazano na rysunku. (2.1)

Następnie za pomocą „czterech plastikowych śrub dostarczonych w pudełce” przytwierdź element ozdobny (6) do lewej i prawej prowadnic ustalających (1). (2.2)

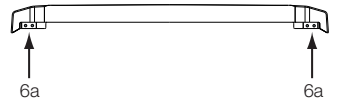

Wskazówka : Do tej operacji użyj śrubokręta elektrycznego.

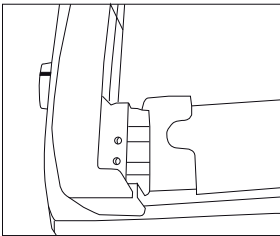

(2.1)

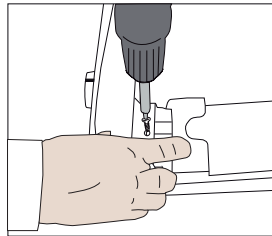

(2.2)

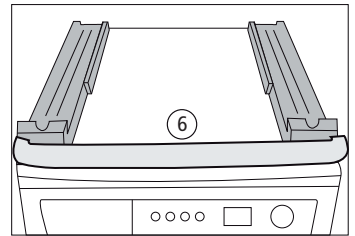

(2.3)

KROK 3 :

Ustaw element dekoracyjny (6) we właściwej pozycji względem górnej powierzchni pralki. (3.1 - 3.2)

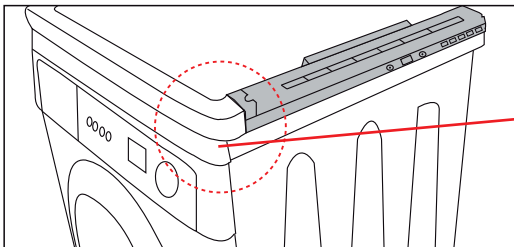

(3.1)

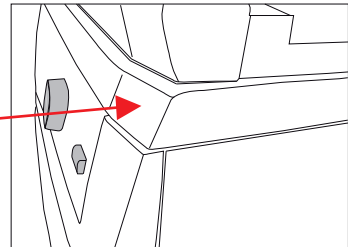

(3.2)

KROK 4 :

Założ tylną płytkę wsporczą (3);

- najpierw na prowadnicę ustalającą (1) jak pokazano na rysunku 4.1. (4.1)

- Następnie dopasuj do rozmieszczenia otworów na korpusie pralki. (4.2)

Wskazówka 1 : Jak pokazano na rys. 4,3, upewnij się, że jest ona prawidłowo osadzona w pokazanej prowadnicy. (4.2)

Wskazówka 2 : Znajdź właściwe położenie śruby (4.4) przesuując ją w prowadnicy ustalającej (1) i zamontuj je śrubami plastikowymi (2). (4.5)

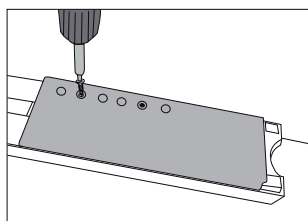
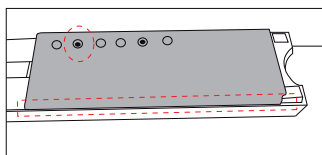
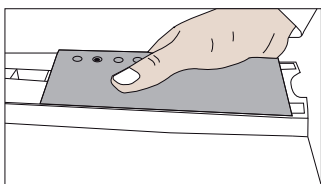
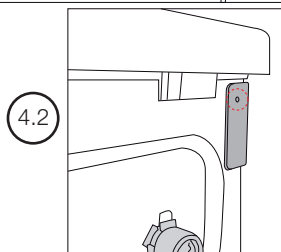
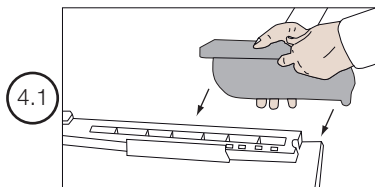

KROK 5 :

Aby połączyć prowadnicę ustalającą (1a-1b) z korpusu pralki,

- **Jak pokazano na rysunku 5.1**, użyj śruby samogwintującej (5a) dostarczonej wraz z Zestawem Montażowym aby ustawić element (3a) na korpusie pralki i wykonać to połączenie.

⚠ Do połączenia w tym kroku **używa się wyłącznie śruby specjalnej nr 5a 1 sztuka używana jest do** tej instalacji. (5.1)

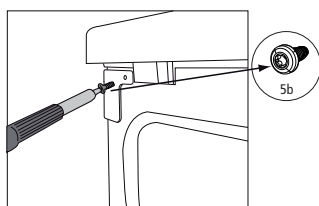
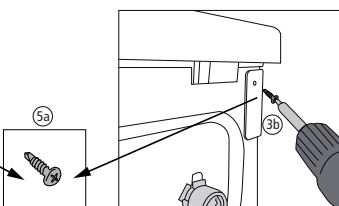
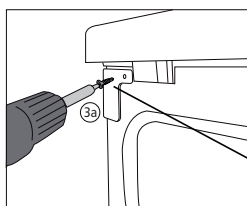

- **Jak pokazano na rysunku 5.2**, użyj śruby samogwintującej (5a) dostarczonej wraz z Zestawem Montażowym aby ustawić element (3b) na korpusie pralki i wykonać to połączenie.

⚠ Do połączenia w tym kroku **używa się wyłącznie śruby specjalnej nr 5a 1 sztuka używana jest do** tej instalacji. (5.2)

⚠ Jeśli w korpusie jest otwór montażowy, użyj wkrętu z główką typu torx (5b) zamiast samogwintującego wiertła (5a). (5.3)

KROK 6 :

Aby umieścić suszarkę bębnową na pralce i Zestawie Montażowym;

 Najpierw otwórz 4 regulowane nóżki suszarki obracając je o 4-6 obrotów. (6.1)

- Podnieś suszarkę korzystając z pomocy co najmniej jednej dodatkowej osoby i umieść ją na prowadnicy ustalającej (1). (6.2)

 Sprawdź stabilność suszarki po otwarciu nóżek.

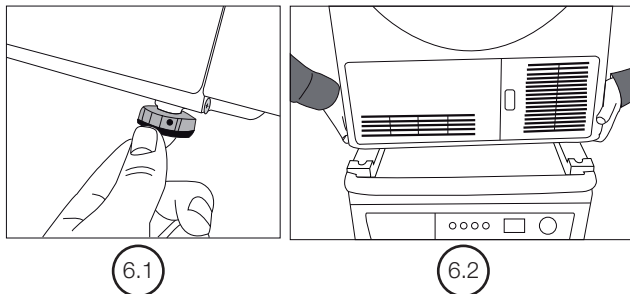

KROK 7 :

Przesuń suszarkę do przodu na prowadnicach ustalających (1). (7.1)

Nadal przesuwaj tę maszynę, aż nóżki trafią do kanału ponad prowadnicą ustalającą (1) i zostaną tam zabezpieczone. (7.2)

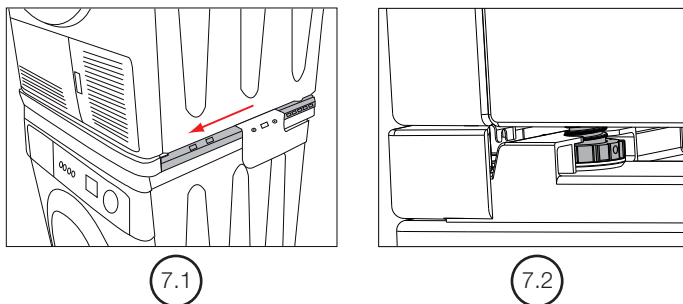

KROK 8 :

Wykręć śruby PT z tylnej części korpusu suszarki, jak pokazano na rysunku z lewej i prawej strony. Śruby te będą użyte później. (8.1)

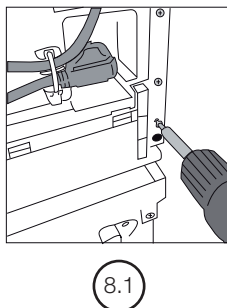

KROK 9 :

Aby połączyć suszarkę z Zestawem Montażowym;

- Podnieś suszarkę popychając ją z tyłu do przodu. Zainstaluj tylny element mocujący (4) na prowadnicy ustalającej (1). (9.1)

! Są dwa rodzaje tylnych elementów ustalających (4a-4b): lewy i prawy. Instalacja w przeciwnym kierunku nie jest możliwa. Ponieważ tylne elementy mocujące zaprojektowano jako lewy i prawy. (4a-4b)

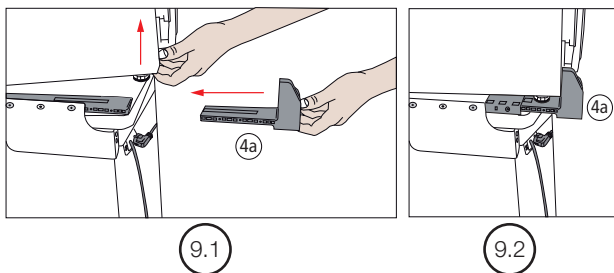

KROK 10 :

Przesuń tylne elementy mocujące (4a - 4b) wewnątrz prowadnicy ustalającej (1a - 1b) na głębokości TD.

- Po tej regulacji, za pomocą śrub wykręconych w kroku 8 zabezpiecz tylne części mocujące do korpusu TD. (10.1)

! Śrubokrętów elektrycznych używaj tylko do połączeń śrubowych.

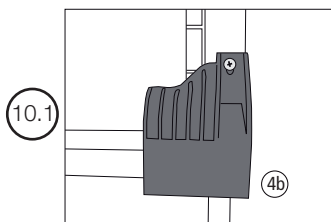

KROK 11 :

Aby zakończyć połączenia pralki, suszarki bębnowej i Zestawu Montażowego;

- Dopasuj odpowiednie otwory między elementami nr 1 oraz 3 i w te dopasowane otwory (2) wkręć śruby plastikowe. (11.1)

- Dokończ instalacji Zestawu Montażowego poprzez wykonanie tej czynności w obu kierunkach.

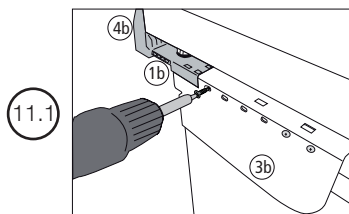

ROMÂNĂ

Nr. piesă	Nume piesă	Nr. piesă	Nume piesă	Nr. piesă	Nume piesă
1	Bază cu fantă de susținere	3	Piesă conectare suport posterior	5	a- Șuruburi cu autofiletare b- Șurub cu capăt gros
2	Șuruburi	4	Element fixare segment posterior	6	Piesă capac frontal

PASUL 1 :

Amplasați piesele din plastic ce constituie baza (1a-1b) livrate în cutie pe mașina de spălat (MS) ca în figură. (1.1)

Sfat : Piesele din imagine trebuie poziționate una în fața celeilalte.

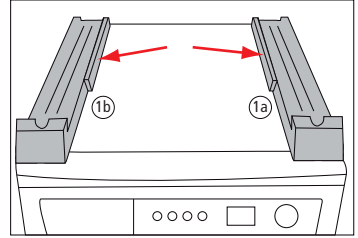

1.1

PASUL 2 :

Plasați piesa cosmetică (6) în partea din față, așa cum se vede în imagine. (2.1)

Apoi, folosiți "șuruburile de plastic furnizate în cutie" pentru a efectua legătura piesei frontale (6) cu baza de susținere, în punctele din stânga și din dreapta (1). (2.2)

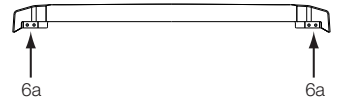

Sfat : Folosiți o șurubelniță electrică pentru această operațiune.

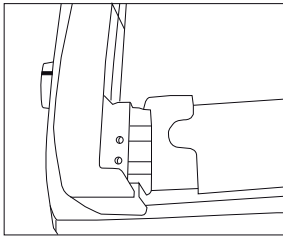

2.1

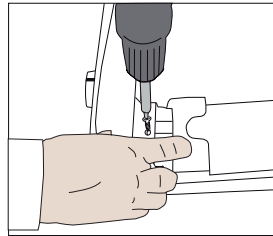

2.2

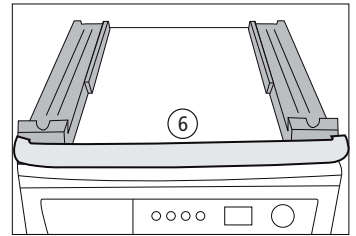

2.3

PASUL 3 :

Aliniați piesă capac frontal (6) în poziția adecvată cu Capacul MS. (3.1-3.2)

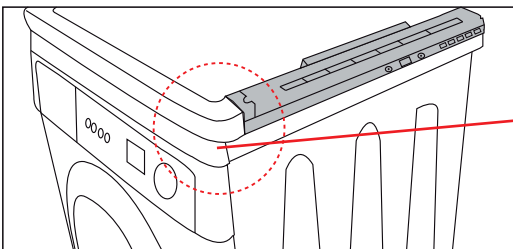

3.1

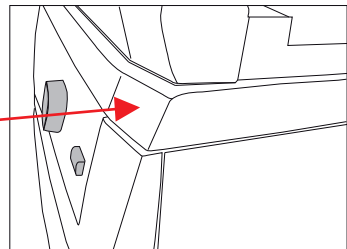

3.2

PASUL 4 :

Amplasați placă posterioară de suport (3) ;

- pe șanțul de reținere (1) așa cum se vede în figura 4.1 mai întâi (4.1)

- Apoi ajustați pozițiile găurilor pe carcasa MS (4.2)

Sfat 1 : Așa cum se vede în figura 4.3, asigurați-vă că stă bine în șanțul arătat.

Sfat 2 : Găsiți pozițiile adecvate pentru șuruburi (4.) mișcând-o pe șanțul de reținere (1) și montați șuruburile de plastic (2). (4.5)

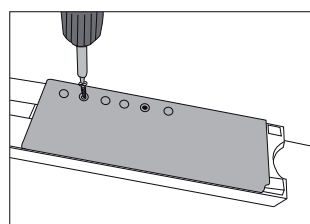
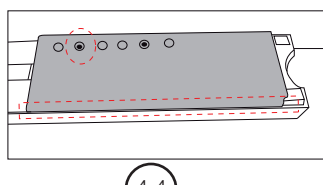
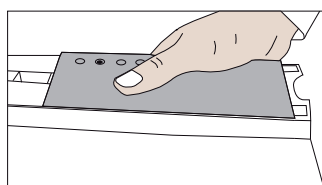
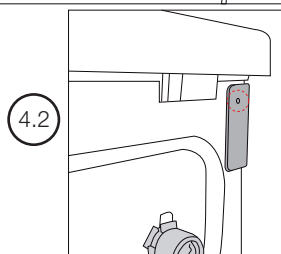
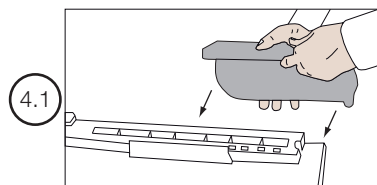

PASUL 5 :

Pentru a conecta șanțul de reținere (1a-1b) la carcasa MS,

- Așa cum se vede în figura 5.1, folosiți șurubul cu autofiletare (5a) furnizat împreună cu ansamblul setului de stivuire pentru a poziționa piesa (3a) pe carcasa MS și efectuați conexiunea.

⚠ Pentru acest pas de conexiune, este folosit doar un **șurub special nr. 5a și 1 singură bucată e folosită** (5.1), pentru instalare.

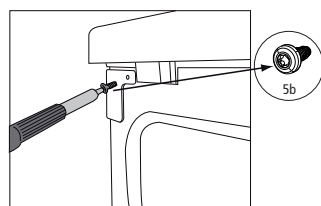
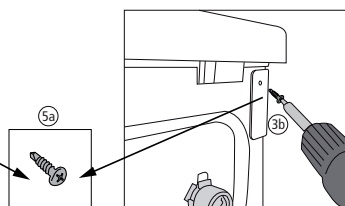
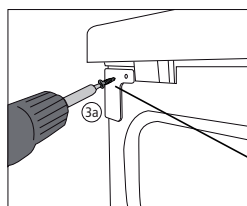

- Așa cum se vede în figura 5.2, folosiți șurubul cu autofiletare (5a) furnizat împreună cu ansamblul setului de stivuire pentru a poziționa piesa (3b) pe carcasa MS și efectuați conexiunea.

⚠ Pentru acest pas de conexiune, este folosit doar un **șurub special nr. 5a și 1 singură bucată e folosită** (5.2), pentru instalare.

⚠ Dacă există o gaură de instalare pe carcasă; folosiți șurubul cu capăt gros (5b) în locul șurubului cu autofiletare tip burghiu (5a) (5.3)

PASUL 6 :

Pentru a amplasa Uscătorul de Rufe (UR) pe mașina de spălat (MS) și ansamblul setului de stivuire;

⚠ Mai întâi desfaceți cele 4 picioare ajustabile ale Uscătorului de Rufe (UR) învârtindu-le 4-6 rotații (6.1).

- Ridicați Uscătorul de Rufe (UR) cu cel puțin încă o persoană și plasați-l pe bază cu fantă de susținere (1) (6.2)

⚠ Verificați stabilitatea UR după desfacerea picioarelor.

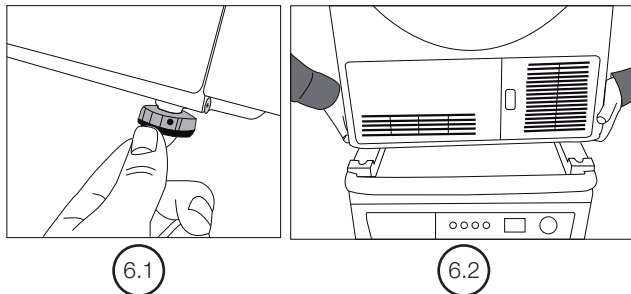

PASUL 7 :

Mutați Uscătorul de Rufe (UR) înainte pe bază cu fantă de susținere (1). (7.1)

Continuați să glisați aparatul până când picioarele sunt fixate pe șanțul de deasupra șanțului de reținere (1). (7.2)

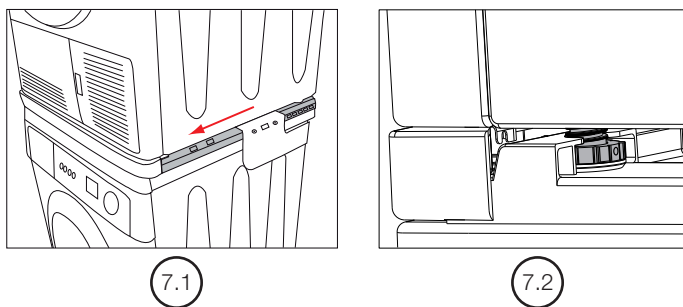

PASUL 8 :

Îndepărtați șuruburile PT din partea posterioară a carcasei UR așa cum se vede în figură, din partea stângă și din partea dreaptă. Aceste șuruburi vor fi folosite mai târziu (8.1)

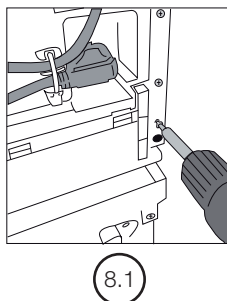

PASUL 9 :

Pentru conexiunea UR și a ansamblului setului de stivuire:

- Ridicați UR împingându-l înainte din partea posterioară. Montați piesa de fixare posterioară (4) la șanțul de reținere (1) (9.1)



Piesele de fixare posterioare (4a-4b) sunt de două feluri: pentru stânga și pentru dreapta. Montarea în direcție inversă este imposibilă deoarece piesele de montare posterioare concepute ca pentru stânga și dreapta (4a-4b).

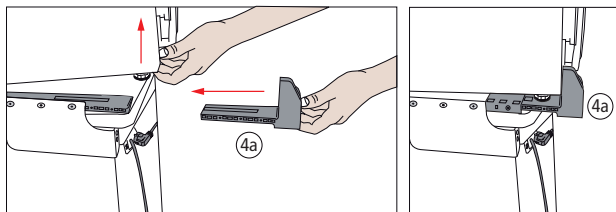

9.1

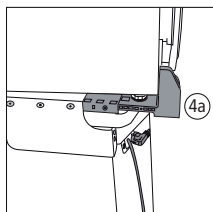

9.2

PASUL 10 :

Mutați piesele de fixare posterioare (4a-4b) în interiorul șanțului de reținere (1a-1b) conform adâncimii UR.

- După această ajustare, folosiți șuruburile îndepărtate în pasul 8 pentru a prinde piesele de reținere posterioare de carcasa UR. (10.1)



Folosiți șurubelnițele electrice doar în timpul conectării șuruburilor.

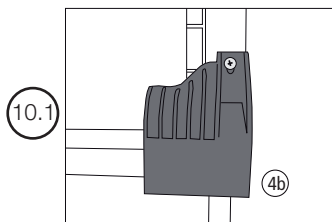

PASUL 11 :

Pentru a termina conexiunile la MS, UR și ansamblul setului de stivuire;

- Potrivii găurile corespunzătoare între piesele nr. 1 și 3 și conectați aceste găuri corespunzătoare (2) cu șuruburi de plastic (11.1)

- Terminați instalarea setului de stivuire efectuând această operațiune în ambele direcții.

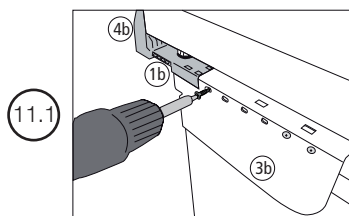

ΕΛΛΗΝΙΚΑ

Αρ. Εξαρτήματος	Όνομα εξαρτήματος	Αρ. Εξαρτήματος	Όνομα εξαρτήματος	Αρ. Εξαρτήματος	Όνομα εξαρτήματος
1	Ράγες συγκράτησης	3	Πίσω εξάρτη για σύνδεσης και στήριξης	5	a - Λαμαρινόβιδες b - Μηχανόβιδα Torx
2	Βίδες	4	Πίσω στοιχείο σταθεροποίησης	6	Διακοσμητικό εξάρτημα

ΒΗΜΑ 1 :

Τοποθετήστε στο Πλυντήριο τα πλαστικά εξαρτήματα συγκράτησης (1a-1b) που περιέχονται στη συσκευασία, όπως δείχνει η εικόνα. (1.1)

Υπόδειξη : Οι επιφάνειες που δείχνει η εικόνα πρέπει να είναι αντικριστά μεταξύ τους.

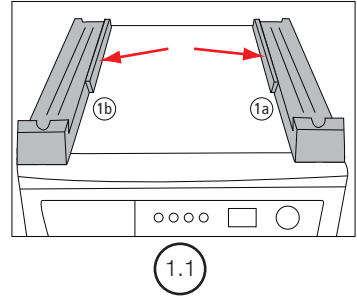

ΒΗΜΑ 2 :

Τοποθετήστε το διακοσμητικό εξάρτημα (6) στην πρόσοψη όπως δείχνει η εικόνα. (2.1)

Κατόπιν χρησιμοποιήστε τις “τέσσερις πλαστικές βίδες που παρέχονται στο κουτί” για να πραγματοποιήσετε τη σύνδεση του διακοσμητικού εξαρτήματος (6) στην αριστερή και στη δεξιά ράγα συγκράτησης (1). (2.2)



Υπόδειξη : Χρησιμοποιήστε ηλεκτρικό κατσαβίδι για αυτή την εργασία.

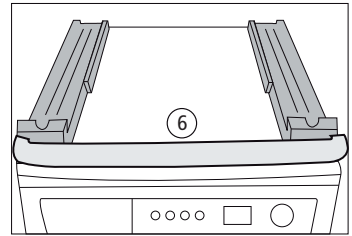
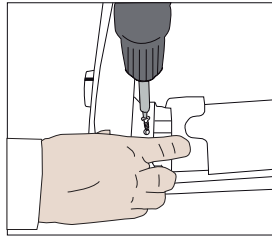
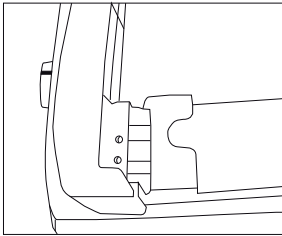

ΒΗΜΑ 3 :

Ευθυγραμμίστε το διακοσμητικό εξάρτημα (6) στη σωστή από αισθητικής άποψης θέση ως προς την πάνω επιφάνεια του Πλυντηρίου. (3.1 - 3.2)

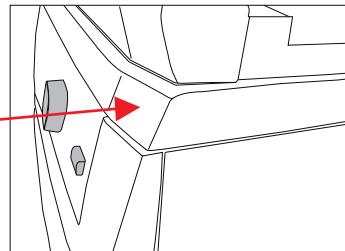
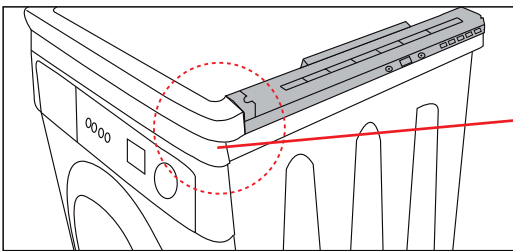

ΒΗΜΑ 4 :

Τοποθετήστε την πίσω πλάκα στήριξης (3);

- πάνω στη ράγα συγκράτησης (1) όπως δείχνει η εικόνα 4.1. (4.1)

- Κατόπιν ρυθμίστε τις θέσεις των οπών με τον κορμό του πλυντηρίου. (4.2)

Υπόδειξη 1 : Όπως δείχνει η εικόνα 4.3, βεβαιωθείτε ότι έχει εδράσει σωστά πάνω στη ράγα συγκράτησης όπως δείχνει η εικόνα.

Υπόδειξη 2 : Βρείτε τη σωστή θέση για τις βίδες (4.4) μετακινώντας το εξάρτημα πάνω στη ράγα συγκράτησης (1) και στερεώστε το με τις πλαστικές βίδες (2). (4.5)

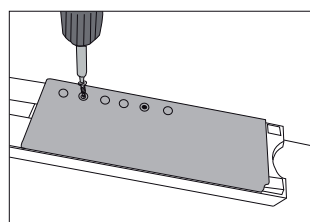
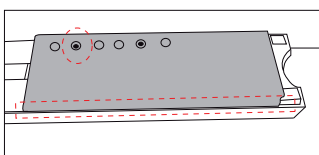
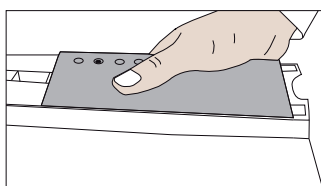
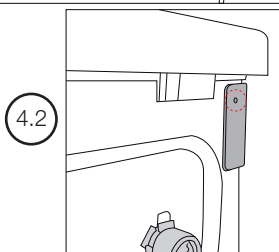
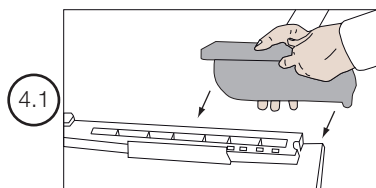

ΒΗΜΑ 5 :

Για να πραγματοποιήσετε τη σύνδεση της ράγας συγκράτησης (1a-1b) με τον κορμό του πλυντηρίου,

- Όπως δείχνει η εικόνα 5.1, χρησιμοποιήστε τη λαμαρινόβίδα (5a) που σας παραδίδεται με το συγκρότημα κιτ στοίβαξης για να τοποθετήσετε το εξάρτημα (3a) πάνω στον κορμό του πλυντηρίου και να πραγματοποιήσετε τη σύνδεση.

⚠ Για τη σύνδεση σε αυτό το βήμα, χρησιμοποιήστε μόνο τη βίδα ειδικού σχεδιασμού αρ. 5a και 1 μόνο τεμάχιο για την εγκατάσταση. (5.1)

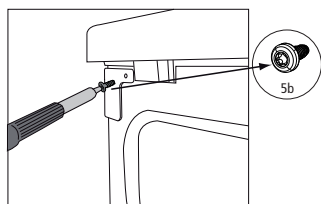
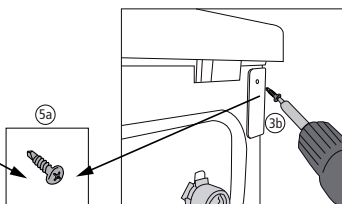
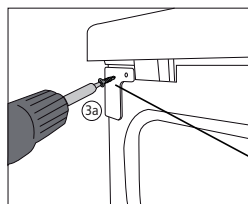

- Όπως δείχνει η εικόνα 5.2, χρησιμοποιήστε τη λαμαρινόβίδα (5a) που σας παραδίδεται με το συγκρότημα κιτ στοίβαξης για να τοποθετήσετε το εξάρτημα (3b) πάνω στον κορμό του πλυντηρίου και να πραγματοποιήσετε τη σύνδεση.

⚠ Για τη σύνδεση σε αυτό το βήμα, χρησιμοποιήστε μόνο τη βίδα ειδικού σχεδιασμού αρ. 5a και 1 μόνο τεμάχιο για την εγκατάσταση. (5.2)

⚠ Αν υπάρχει οπή εγκατάστασης στον κορμό, χρησιμοποιήστε τη μηχανόβίδα Torx (5b) αντί για τη λαμαρινόβίδα (5a). (5.3)

ΒΗΜΑ 6 :

Για να τοποθετήσετε το Στεγνωτήριο πάνω στο Πλυντήριο και το συγκρότημα κιτ στοίβαξης:

⚠ Πρώτα ανοίξτε τα 4 ρυθμιζόμενα πόδια του Στεγνωτηρίου περιστρέφοντάς τα 4-6 στροφές. (6.1)

- Σηκώστε το Στεγνωτήριο με τουλάχιστον δύο άτομα, και τοποθετήστε το πάνω στη ράγα συγκράτησης (1). (6.2)

⚠ Ελέγξτε τη σταθερότητα του Στεγνωτηρίου μετά το άνοιγμα των ποδιών του.

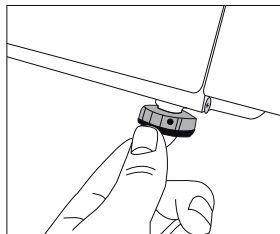

6.1

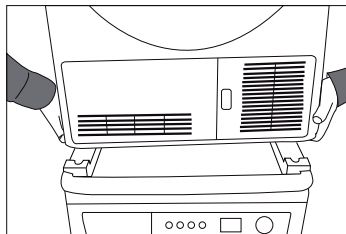

6.2

ΒΗΜΑ 7 :

Μετακινήστε το Στεγνωτήριο προς τα εμπρός πάνω στις ράγες συγκράτησης (1). (7.1)

Συνεχίστε να μετακινείτε τη συσκευή έως ότου τα πόδια τοποθετηθούν και ασφαλιστούν στις υποδοχές πάνω από τη ράγα συγκράτησης (1). (7.2)

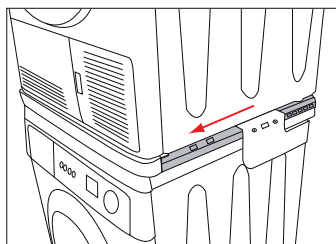

7.1

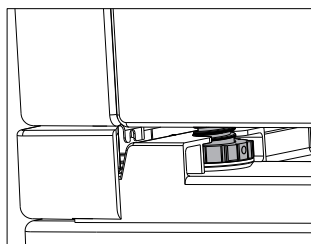

7.2

ΒΗΜΑ 8 :

Αφαιρέστε τις βίδες PT από την πίσω πλευρά του κορμού του Στεγνωτηρίου όπως δείχνει η εικόνα, από την αριστερή και τη δεξιά πλευρά. Αυτές οι βίδες θα χρησιμοποιηθούν αργότερα. (8.1)

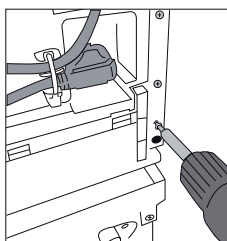

8.1

ΒΗΜΑ 9 :

Για τη σύνδεση του Στεγνωτήριου και του συγκροτήματος του κιτ στοίβαξης:

- Ανυψώστε το Στεγνωτήριο σπρώχνοντάς το προς τα εμπρός από την πίσω πλευρά. Εγκαταστήστε το πίσω στοιχείο σταθεροποίησης (4) στη ράγα συγκράτησης (1). (9.1)

! Τα πίσω εξαρτήματα σταθεροποίησης (4a-4b) έχουν δύο τύπους: αριστερό και δεξιό. Η εγκατάσταση σε αντίθετη κατεύθυνση δεν είναι εφικτή. Ο λόγος είναι ότι τα πίσω εξαρτήματα σταθεροποίησης έχουν σχεδιαστεί ως αριστερό και δεξιό. (4a-4b)

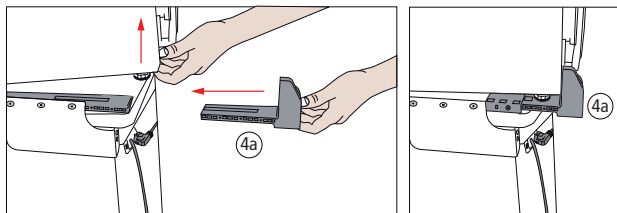

9.1

9.2

ΒΗΜΑ 10 :

Μετακινήστε τα πίσω εξαρτήματα σταθεροποίησης (4a-4b) μέσα στη ράγα συγκράτησης (1a-1b) σύμφωνα με το βάθος του Στεγνωτήριου.

- Μετά από αυτή τη ρύθμιση, χρησιμοποιήστε τις βίδες που αφαιρέσατε στο βήμα 8 για να στερεώσετε τα πίσω εξαρτήματα συγκράτησης στον κορμό του Στεγνωτήριου. (10.1)

! Χρησιμοποιήστε μόνο ηλεκτρικό καταβίδι για τη σύνδεση των βιδών.

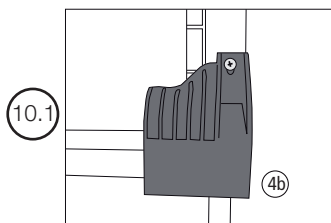

ΒΗΜΑ 11 :

Για να ολοκληρώσετε τις συνδέσεις Πλυντηρίου, Στεγνωτήριου και συγκροτήματος κιτ στοίβαξης:

- Ταιριάξτε τις αντίστοιχες οπές ανάμεσα στα εξαρτήματα αρ. 1 και 3 και συνδέστε αυτές τις αντίστοιχες οπές (2) με πλαστικές βίδες. (11.1)

- Ολοκληρώστε την εγκατάσταση του κιτ στοίβαξης πραγματοποιώντας αυτή την εργασία και στις δύο πλευρές.

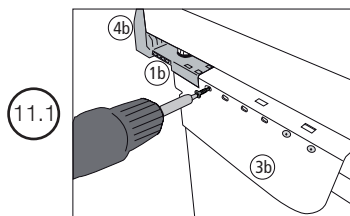

ČEŠTINA

Číslo dílu	Název příslušenství	Číslo dílu	Název příslušenství	Číslo dílu	Název příslušenství
1	Přidržovací vedení	3	Zadní přípojny podpůrný prvek	5	a - Samořezné šrouby b - Torx šroub s tupým koncem
2	Šrouby	4	Zadní upevňovací prvek	6	Ozdobná lišta

KROK č. 1:

Umístěte pojistné plastové vedení (1a-1b) dodané v krabici pračky, jak je znázorněno na obrázku. (1.1)

Pokyn : Plochy na obrázku musí být tváří proti sobě.

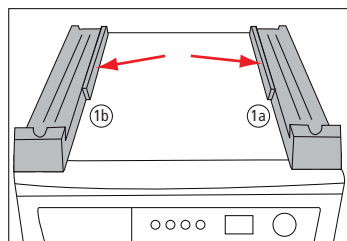

1.1

KROK č. 2:

Umístěte ozdobnou lištu (6) na čelní stranu, jak je znázorněno na obrázku. (2.1)

Pak použijte "plastové šrouby dodávané v krabici" pro připojení ozdobné lišty (6) vlevo a vpravo do přidržovacích vedení (1). (2.2)

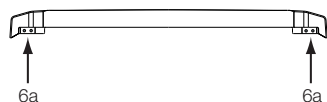

6a

6a

Pokyn : Pro tuto operaci použijte elektrický šroubovák.

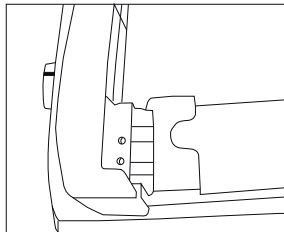

2.1

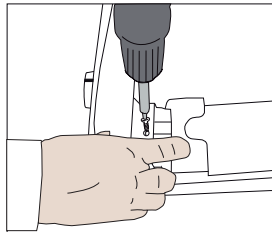

2.2

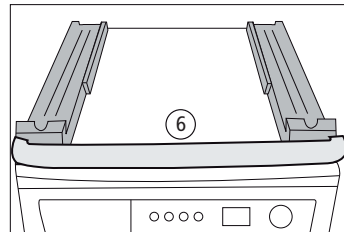

2.3

KROK č. 3:

Umístěte ozdobnou lištu (6) do vhodné vizuální polohy s horní policí pračky. (3.1 - 3.2)

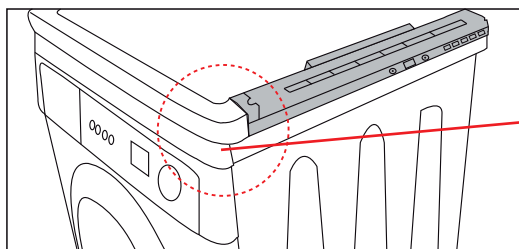

3.1

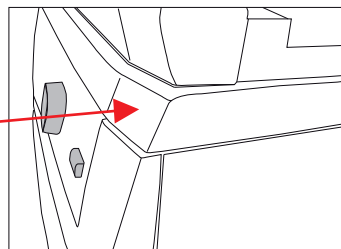

3.2

KROK č. 4:

Umístěte zadní podpůrnou desku (3);

- nejprve na přídržovací vedení (1), jak je znázorněno na obrázku č. 4.1. (4.1)

- poté upravte pozici otvorů na těle pračky. (4.2)

Pokyn 1 : Jak je znázorněno na obrázku č. 4.3, zkontrolujte, zda sedí správně na zobrazeném přídržovacím vedení.

Pokyn 2 : Pohybováním najdete správnou polohu šroubů (4.4) na přídržovacích vedeních (1) a přišroubujte jejich plastovými šrouby (2). (4.5)

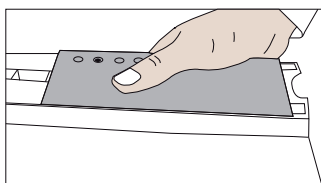

4.3

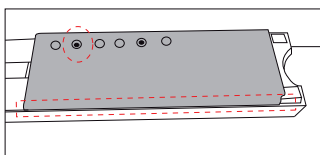

4.4

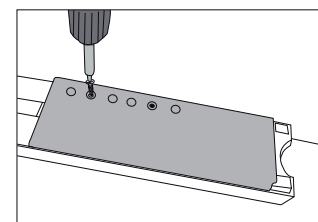

4.5

KROK č. 5 :

Pro připojení přídržovacích vedení (1a-1b) k tělesu pračky,

- Jak je uvedeno na obrázku číslo 5.1, použijte samořezné šrouby (5a) dodávané se stohovací sadou s cílem umístění části (3a) na tělo pračky a upevněte spojení.

! Pro připojení v tomto kroku, šroub se speciálním tvarem č. 5a použijte pouze pro instalaci 1. použitého kusu (5.1).

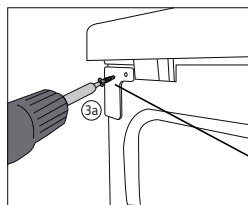

5.1

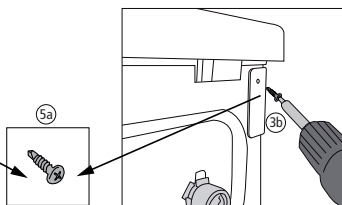

5.2

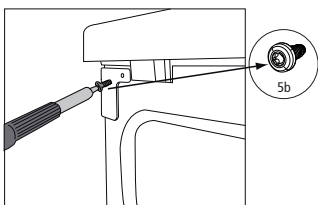

5.3

Jak je znázorněno na obrázku č. 5.2, použijte samořezné šrouby (5a) dodávané se stohovací sadou s cílem umístění části (3b) na tělo pračky a upevněte spojení.

! Pro připojení v tomto kroku, šroub se speciálním tvarem č. 5a použijte pouze pro instalaci 2. použitého kusu (5.2).

! V případě, že se na těle pračky instalacním otvor; použijte Torx Šroub s tupým koncem (5b) namísto samořezného šroubu (5a). (5.3)

KROK č. 6:

Umístění sušičky na pračku a na stohovací sady;

⚠ Jako první otevřete 4 nastavitelné nohy sušičky jejich otočením o 4-6 otáček. (6.1)

Zvedněte sušičku s pomocí nejméně dvou osob a umístěte ji na přídržovací vedení (1). (6.2)

⚠ Zkontrolujte stabilitu sušičky po otevření jejích nohou.

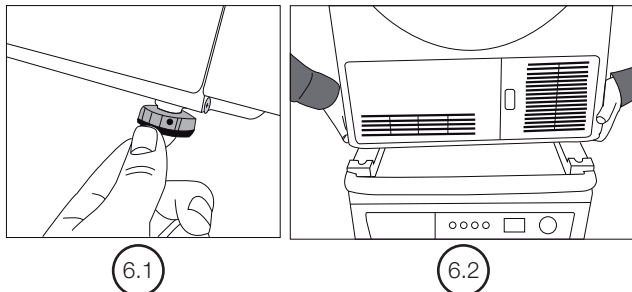

KROK č. 7 :

Zatáhněte sušičku vpřed na přídržovacích vedeních (1). (7.1)

Pokračujte v tažení chladničky, zatímco nohy nezapadnou a nezajistí se v drážce přídržovacího vedení (1). (7.2)

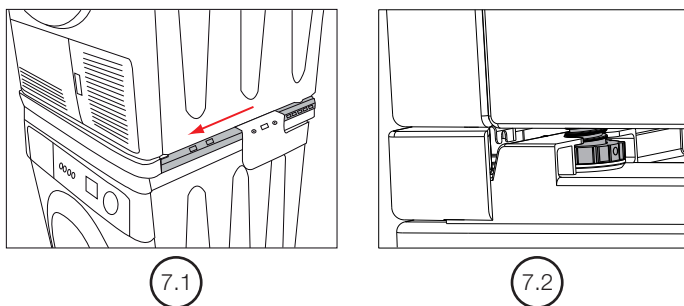

KROK č. 8 :

Odstraňte PT šrouby ze zadní strany těla sušičky, jak je znázorněno na obrázku, z levé i pravé strany. Tyto šrouby budou použity později. (8.1)

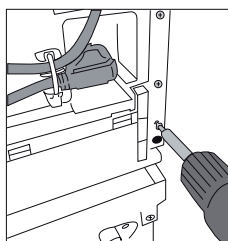

KROK č. 9 :

KM ve Stacking Kit grubu bağlantisinin yapılması için ;

- Zvedněte sušičku jejím zatlačením dopředu ze zadní části. Připevněte zadní upevňovací část (4) na přídržovací vedení (1). (9.1)

⚠ Zadní podpůrné díly mají dva typy (4a, 4b): levé a pravé. Montáž v opačném směru není možný. Vzhledem k tomu, že zadní podpůrné díly jsou navrženy jako levé a pravé. (4a-4b)

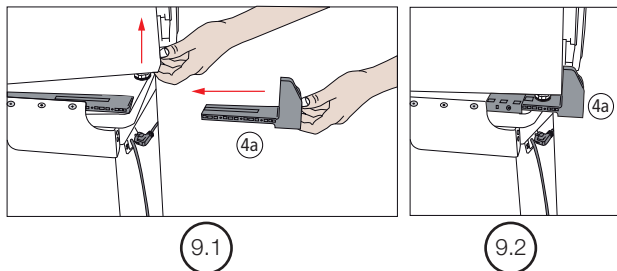

KROK č. 10 :

Posuňte zadní upevňovací části (4a, 4b) dovnitř přídržovacího vedení (1a-1b) do hloubky jako je sušička. (10.1)

- Po tomto nastavení, pomocí šroubů vyňatých v kroku 8 zajistěte zadní upevňovací díly na tělo sušičky. (10.1)

⚠ Elektrické šroubováky použijte pouze v případě šroubových spojů.

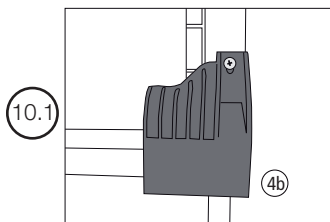

KROK č. 11 :

Pro dokončení spojení pračky, sušičky a stohovací sady;

- Přisuňte k sobě příslušející otvory mezi částmi 1 a 3 a spojte je plastovými šrouby (2). (11.1)

- Dokončete instalaci stohovací sady provedením tohoto postupu v obou směrech.

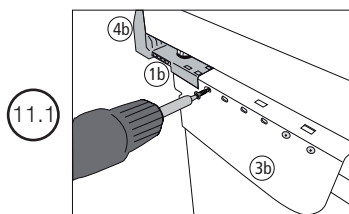

LIETUVIŲ K.

Dalies Nr.	Dalies pavadinimas	Dalies Nr.	Dalies pavadinimas	Dalies Nr.	Dalies pavadinimas
1	Surinkimo kanalai	3	Galinės atramos prijungiamoji dalis	5	a - Savisriegiai varžtai b - Torcinis varžtas plokščiu galu
2	Varžtai	4	Galinis tvirtinimo elementas	6	Apdailos dalis

1 VEIKSMAS:

Sudėkite plastikinės surinkimo dalis (1a-1b), pristatytas skalbimo mašinos dėžėje, kaip pavaizduota pav. (1.1)

Patarimas : Geometriniai paviršiai iliustracijoje turi būti atsukti vienas į kitą.

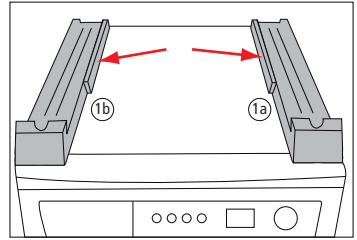

1.1

2 VEIKSMAS:

Apdailos dalį (6) padėkite, kaip pavaizduota pav. (2.1)

Plastikiniais varžtais iš dėžutės sujunkite dalį (6) su kairiuoju ir dešiniuoju surinkimo kanalais (1). (2.2)

Patarimas : Naudokite akumuliatorinį atsuktuvą šiai operacijai.

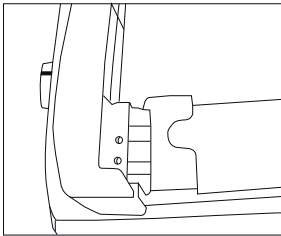
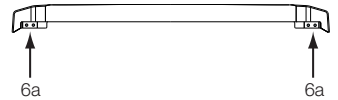

2.1

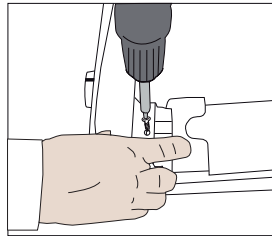

2.2

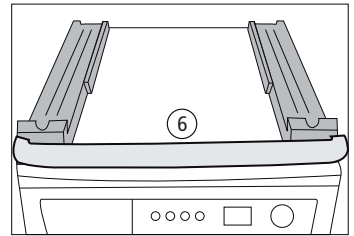

2.3

3 VEIKSMAS:

Išlygiuokite apdailos dalį (6) į reikalingą vietą pagal skalbimo mašinos viršutinį dėklą. (3.1-3.2)

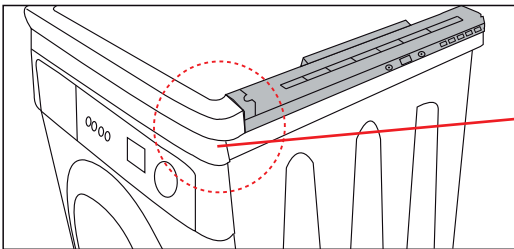

3.1

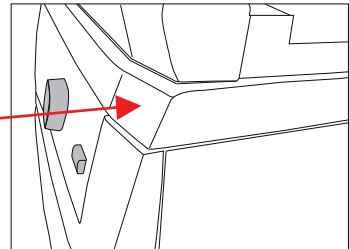

3.2

4 VEIKSMAS:

Uždėkite galinę atraminę plokštę (3);

- ant surinkimo kanalo (1), kaip pavaizduota 4.1 pav. (4.1)

- Po to išlygiuokite pagal angų vietas ant skalbimo mašinos. (4.2)

1 patarimas: Kaip pavaizduota 4.3 pav., užtikrinkite, kad ji tinkamai įsistatytų ant pavaizduoto kanalo.

2 patarimas: Raskite tinkamas vietas varžtams (4.4) pajudindami surinkimo kanalą (1) ir prisukdami plastikinius varžtus (2). (4.5)

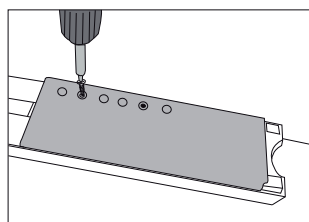
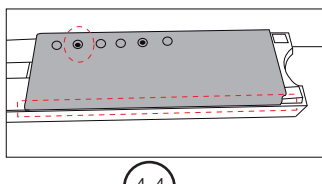
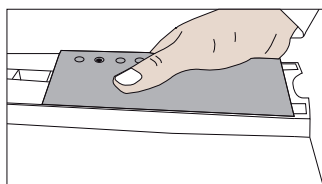
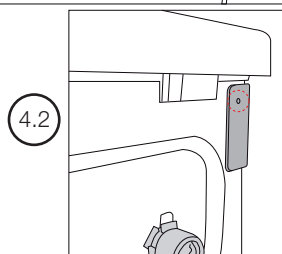
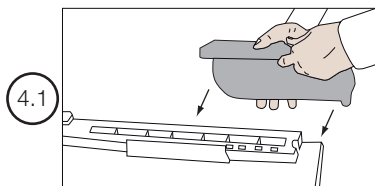

5 VEIKSMAS:

Norėdami sujungti surinkimo kanalą (1a-1b) prie skalbimo mašinos,

- Kaip pavaizduota 5.1 pav., naudokite savisriegį varžtą (5a), pateiktą su bloku, nustatykite reikalingą padėtį ant skalbimo mašinos (3a) dalies ir sujunkite.

⚠ Sujungimui šiame veiksme naudokite vieną specialaus dizaino varžtą 5a. (5.1)

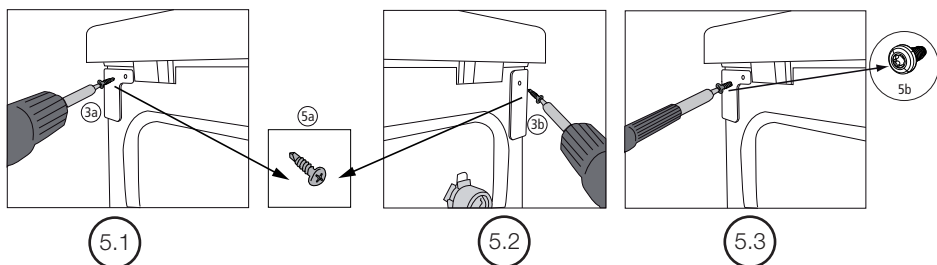

- Kaip pavaizduota 5.2 pav., naudokite savisriegį varžtą (5a), pateiktą su bloku, nustatykite reikalingą (3b) dalies padėtį ant skalbimo mašinos ir sujunkite.

⚠ Sujungimui šiame veiksme naudokite du specialaus dizaino varžtus 5a. (5.2)

⚠ Jei ant korpuso yra montavimo anga, naudokite torcinį varžtą plokščiu galu (5b), o ne savisriegį akumulatoriniu suktuvu įsukamą varžtą (5a). (5.3)

6 VEIKSMAS:

Norėdami uždėti suktuvą ant skalbimo mašinos ir krovimo bloko;

 iš pradžių atlenkite 4 reguliuojamas suktuvo kojeles, pasukdami jas 4-6 apsisukimus. (6.1)

- Mažiausiai du žmonės turi pakelti suktuvą ir užkelti ant surinkimo kanalo (1). (6.2)

 Atidarę kojeles patikrinkite suktuvo stabilumą.

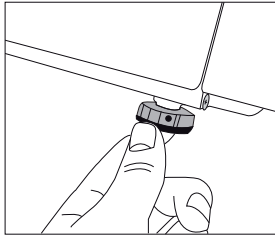

6.1

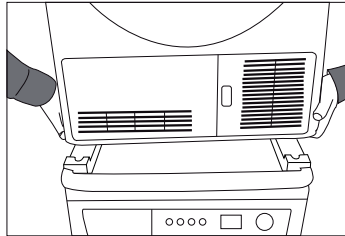

6.2

7 VEIKSMAS:

Pastumkite suktuvą pirmyn ant surinkimo kanalų (1). (7.1)

Toliau stumkite mašinos kojeles, kol jos atsirems ir įsiremt į kanalą virš surinkimo kanalo (1). (7.2)

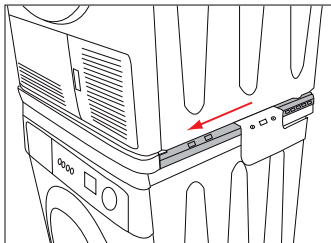

7.1

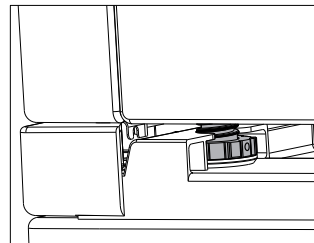

7.2

8 VEIKSMAS:

Išsukite PT varžtus iš galinės suktuvo dalies, kaip pavaizduota pav., iš kairės ir iš dešinės pusės. Šiuos varžtus reikės panaudoti vėliau. (8.1)

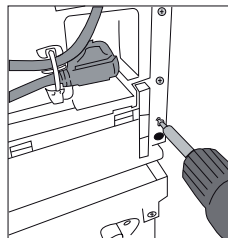

8.1

9 VEIKSMAS:

Norėdami sujungti sukтуvą ir krovimo bloką;

- Pakelkite sukтуvą pastumdami į priekį iš galinės pusės. Įstatykite galinę tvirtinimo dalį (4) į surinkimo kanalo (1) dalį. (9.1)

⚠ Galinės tvirtinimo dalys (4a-4b) yra dviejų tipų: kairinės ir dešinės. Priešinga kryptimi sumontuoti negalima. Galinės tvirtinimo dalys yra kairinės ir dešinės. (4a-4b)

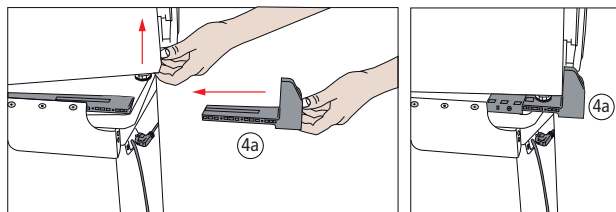

9.1

9.2

10 VEIKSMAS:

Įstatykite galines tvirtinimo dalis (4a-4b) į surinkimo kanalą (1a-1b) iki reikalingo sukтуvo gylio.

- Po šio pakoregavimo pritvirtinkite galines fiksavimo dalis prie sukтуvo varžtais, kuriuos išsukote 8 veiksmo tely sušičky.(10.1)

⚠ Varžtus susukite tik akumuliatoriniu sukтуvu.

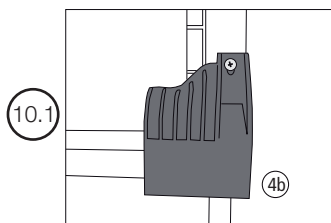

11 VEIKSMAS :

Norėdami baigti skalbimo mašinos, sukтуvo ir krovimo bloko sujungimą;

- Atitaisykite atitinkamas angas tarp 1 ir 3 dalies, į šias atitinkančias angas (2) susukite plastikinius varžtais. (11.1)

- Baikite krovimo bloko sumontavimą atlikdami šią procedūrą abiem kryptimis.

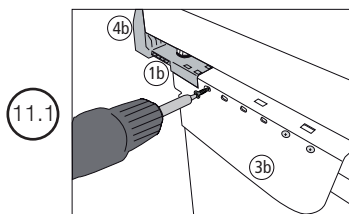

LATVISKI

Daļas nr.	Daļas nosaukums	Daļas nr.	Daļas nosaukums	Daļas nr.	Daļas nosaukums
1	Aizturošās vadslīdes	3	Aizmugures balsta savienojuma detaļa	5	a - pašvītngriezes skrūve b - gremdgaļvas skrūve
2	Skrūves	4	Aizmugures fiksējošais elements	6	Dekoratīvā detaļa

1. DARBĪBA :

Novietojiet plastmasas aizturošās detaļas (1a-1b) uz veļas mazgājamās mašīnas tā, kā parādīts attēlā. (1.1)

Padoms : Ģeometriskajām virsmām ir jābūt vērstām vienai pret otru.

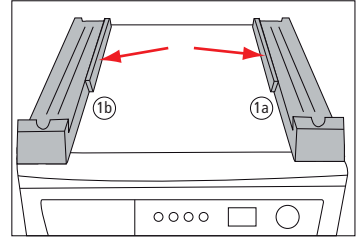

1.1

2. DARBĪBA :

Novietojiet dekoratīvo detaļu (6) priekšpusē tā, kā parādīts attēlā. (2.1)

Pievienojiet dekoratīvo detaļu (6) labās un kreisās puses aizturošajām vadslīdēm (1), izmantojot komplektācijā iekļautās plastmasas paredzētās skrūves. (2.2)

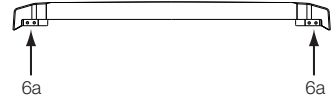

Hint : Šīs darbības veikšanai izmantojiet elektrisko skrūvgrīzi.

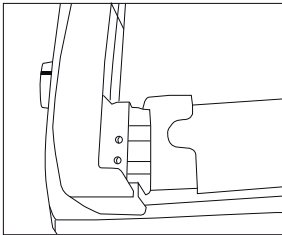

2.1

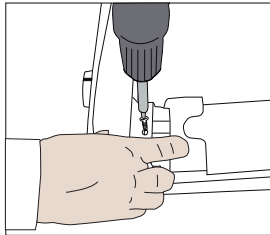

2.2

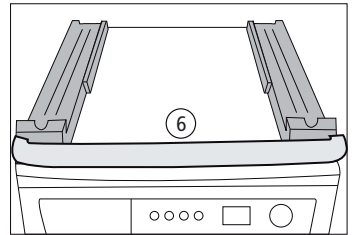

2.3

3. DARBĪBA :

Novietojiet dekoratīvo detaļu (6) vizuāli atbilstošajā vietā vienā līmenī ar veļas mazgājamās mašīnas augšējo malu. (3.1 - 3.2)

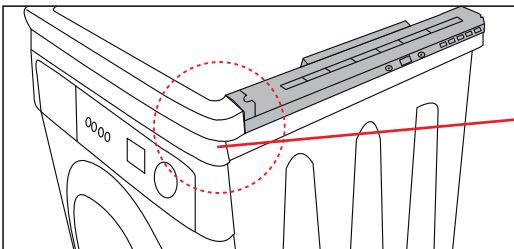

3.1

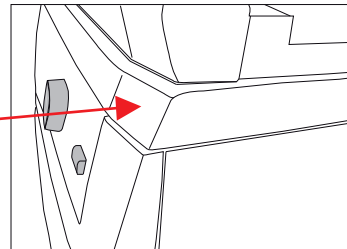

3.2

4. DARBĪBA :

Novietojiet aizmugures balsta plāksni (3) ;

- uz aizturošās vadsliedes (1) tā, kā parādīts attēlā 4.1; (4.1)

- pēc tam piergulējiet urbumu atrašanās vietas veļas mazgājamās mašīnas korpusam. (4.2)

1. padoms : Pārliecinieties, ka plāksne ir precīzi ievietota vadsliedē tā, kā norādīts attēlā 4.3.

2. padoms : Atrodiet skrūvju pareizo atrašanās vietu (4.4), virzot plāksni pa aizturošo vadsliedi (1), un nofiksējiet to, izmantojot plastmasai paredzētās skrūves (2). (4.5)

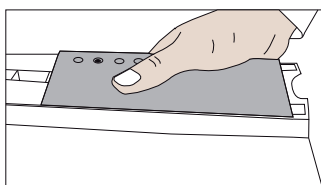

4.3

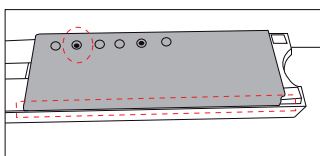

4.4

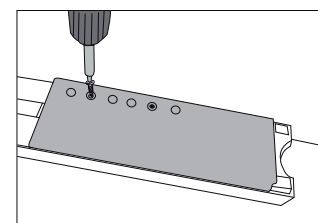

4.5

5. DARBĪBA :

Lai savienotu aizturošās vadsliedes (1a-1b) ar veļas mazgājamās mašīnas korpusu,

- Detaļas (3a) pozicionēšanai uz veļas mazgājamās mašīnas korpusa un tās pieskrūvēšanai izmantojiet komplektācijā iekļauto pašvītņgriezes skrūvi (5a). Skat. attēlu 5.1.

⚠ Šīs darbības veikšanai tiek izmantota īpašā veida skrūve 5a, un nostiprināšanai tiek izmantota tikai viena skrūve. (5.1)

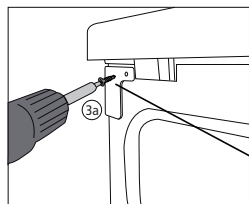

5.1

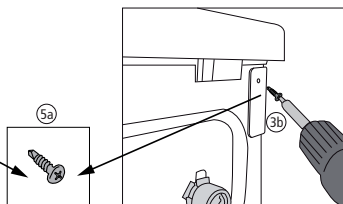

5.2

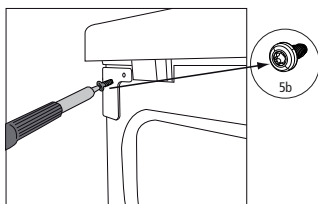

5.3

- Detaļas (3b) pozicionēšanai uz veļas mazgājamās mašīnas korpusa un tās pieskrūvēšanai izmantojiet komplektācijā iekļauto pašvītņgriezes skrūvi (5a). Skat. attēlu 5.2.

⚠ Šīs darbības veikšanai tiek izmantota īpašā veida skrūve 5a, un nostiprināšanai tiek izmantotas divas skrūves. (5.2)

⚠ Ja veļas mazgājamās mašīnas korpusā ir skrūvcaurums, pašvītņgriezes skrūves (5a) vietā izmantojiet gremdgalvas skrūvi (5b). (5.3)

6. DARBĪBA :

Lai novietotu veļas žāvētāju uz veļas mazgājamās mašīnas un stiprinājuma komplekta, veiciet turpmāk norādītās darbības;

⚠ Atskrūvējiet veļas žāvētāja 4 regulējamās kājiņas, pagriežot tās 4-6 apgriezienus. (6.1)

- Paceliet veļas žāvētāju (šī darba veikšanai nepieciešamas vismaz 2 personas) un novietojiet to uz aizmurošās vadslīdes (1). (6.2)

⚠ Pēc kājiņu atskrūvēšanas pārbaudiet veļas žāvētāja stabilitāti.

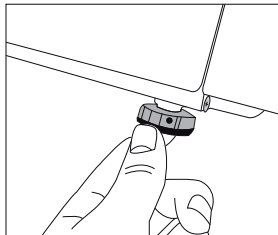

6.1

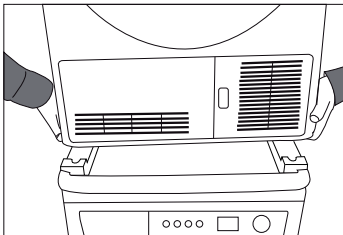

6.2

7. DARBĪBA :

Virziet veļas žāvētāju pa aizmurošajām vadslīdēm (1) uz priekšu. (7.1)

Turpiniet virzīt veļas žāvētāju, līdz kājiņas droši balstās uz aizmurošās vadslīdes (1) slīdes un nofiksējas tajā. (7.2)

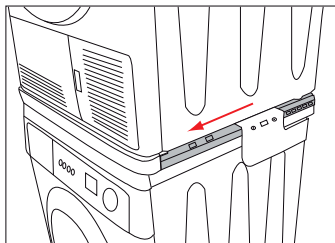

7.1

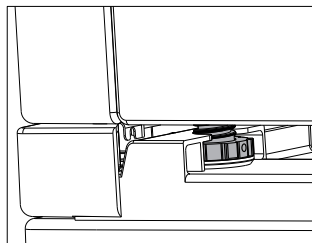

7.2

8. DARBĪBA :

Veļas žāvētāja korpusa aizmugurē labajā un kreisajā pusē izskrūvējiet skrūves tā, kā parādīts attēla. Šīs skrūves tiks izmantotas vēlāk. (8.1)

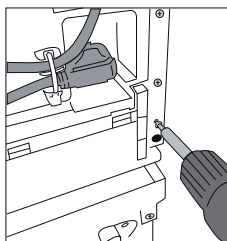

8.1

9. DARBĪBA :

Lai nostiprinātu veļas žāvētāju uz stiprinājuma komplekta, veiciet turpmāk norādītās darbības;

- Paceliet veļas žāvētāju, pastumjot to uz priekšu no tā aizmugures. Uzstādiet aizmugures fiksējošo elementu (4) aizturošās vadsliedes (1) detaļai. (9.1)

⚠ Ir divu veidu aizmugures aizturošās detaļas (4a-4b) — labās puses detaļa un kreisās puses detaļa. To uzstādīšana otrādi nav iespējama, jo arī aizmugures fiksējošajiem elementiem ir īpaša labās un kreisās puses konstrukcija. (4a-4b)

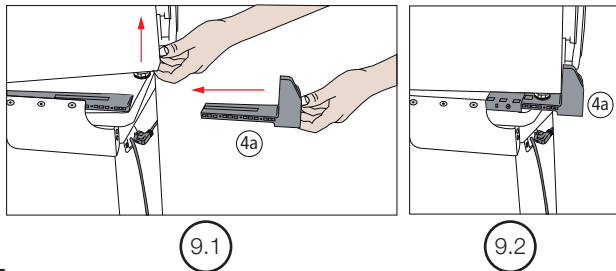

10. DARBĪBA :

levietojiet aizmugures fiksējošos elementus (4a-4b) aizturošajās vadsliedēs (1a-1b) atbilstoši veļas žāvētāja dziļumam.

- Pēc šī noregulēšanas procesa pabeigšanas izmantojiet 8. darbībā izskrūvētās skrūves, lai pieskrūvētu aizmugures aizturošās detaļas veļas žāvētāja korpusam.(10.1)

⚠ Izmantojiet elektrisko skrūvgrīzi tikai, lai ieskrūvētu skrūves.

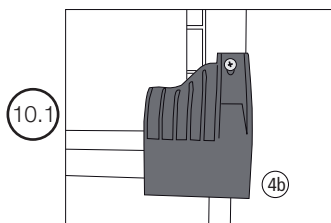

11. DARBĪBA :

Lai pabeigtu veļas mazgājamās mašīnas, veļas žāvētāja un stiprinājuma komplekta montāžu, veiciet turpmāk norādītās darbības;

- vienu virs otra novietojiet detaļu nr. 1 un nr. 3 attiecīgos skrūvcaurumus un savienojiet atbilstošos skrūvcaurumus (2), izmantojot plastmasai paredzētās skrūves. (11.1)

- Pabeidziet stiprinājuma komplekta uzstādīšanu, veicot šo darbību abās pusēs.

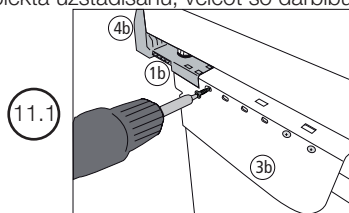

SLOVENČINA

Číslo diela	Názov príslušenstva	Číslo diela	Názov príslušenstva	Číslo diela	Názov príslušenstva
1	Pridržiavacie vedenia	3	Zadný prípojný podporný prvok	5	a- Samorezné skrutky b - Torx Skrutka s tupým koncom
2	Skrutky	4	Zadný upevňovací prvok	6	Ozdobná lišta

KROK č. 1 :

Umiestnite poistné plastové vedenia (1a-1b) dodané v krabici práčky, ako je znázornené na obrázku. (1.1)

Pokyn : Plochy na obrázku musia byť tvárou proti sebe.

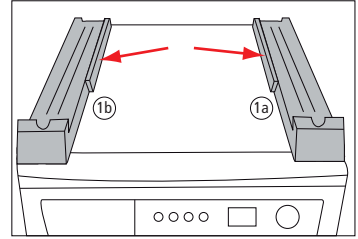

(1.1)

KROK č. 2 :

Umiestnite ozdobnú lištu (6) na čelnú stranu, ako je znázornené na obrázku. (2.1)

Potom použite "plastové skrutky dodávané v krabici" pre pripojenie ozdobnej lišty (6) vľavo a vpravo do pridržiavacích vedení (1). (2.2)

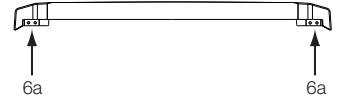

Pokyn : Pre túto operáciu použite elektrický skrutkovač.

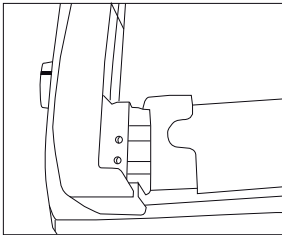

(2.1)

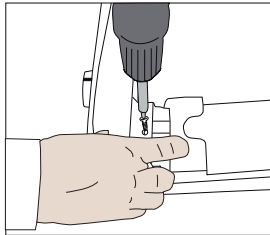

(2.2)

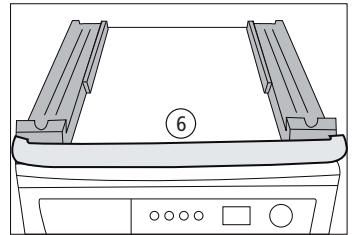

(2.3)

KROK č. 3 :

Umiestnite ozdobnú lištu (6) do vhodnej vizuálnej polohy s hornou policou práčky. (3.1 - 3.2)

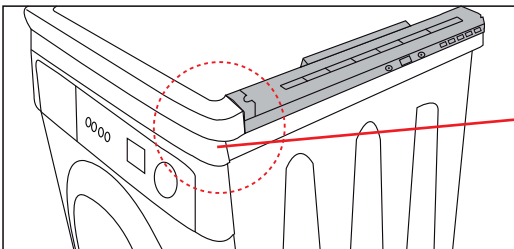

(3.1)

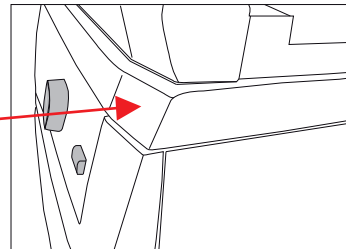

(3.2)

KROK č. 4 :

Umiestnite zadnú podpornú dosku (3) ;

- najprv na pridržiavacie vedenia (1), ako je znázornené na obrázku č. 4.1. (4.1)

- Potom upravte pozíciu otvorov na tele práčky. (4.2)

Pokyn 1 : Ako je znázornené na obrázku č. 4.3, skontrolujte, či sedí správne na zobrazenom pridržiavacom vedení.

Pokyn 2 : Pohybovaním nájdite správnu polohu skrutiek (4.4) na pridržiavacích vedeniach (1) a priskrutkujte ich plastovými skrutkami (2). (4.5)

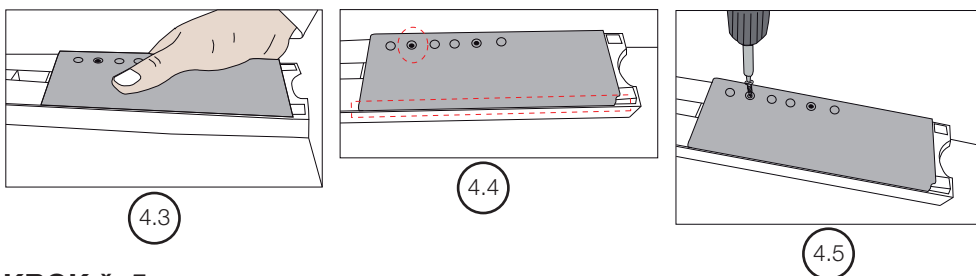

KROK č. 5 :

Pre pripojenie pridržiavacích vedení (1a-1b) k telesu práčky,

- Ako je uvedené na obrázku číslo 5.1, použite samorezné skrutky (5a) dodávané so Stohovacou sadou s cieľom umiestnenia časti (3a) na telo práčky a upevnite spojenie.

⚠ Pre pripojenie v tomto kroku, skrutku so špeciálnym tvarom č. 5a použite iba pre inštaláciu 1. použitého kusu (5.1).

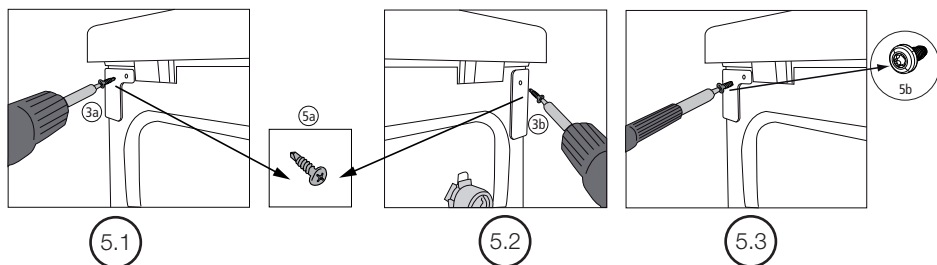

- Ako je znázornené na obrázku č. 5.2, použite samorezné skrutky (5a) dodávané so Stohovacou sadou s cieľom umiestnenia časti (3b) na telo práčky a upevnite spojenie.

⚠ Pre pripojenie v tomto kroku, skrutku so špeciálnym tvarom č. 5a použite iba pre inštaláciu 2. použitého kusu (5.2).

⚠ V prípade, ak sa na tele práčky nachádza inštaláčny otvor; použite Torx Skrutka s tupým koncom (5b) namiesto samoreznej skrutky (5a). (5.3)

KROK č. 6 :

Umiestnenie sušičky na práčku a na Stohovaciu sadu;

! Ako prvé otvorte 4 nastaviteľné nohy sušičky ich otočením o 4-6 otáčok. (6.1)

- Zdvihnite sušičku s pomocou najmenej dvoch osôb a umiestnite ju na pridržiavacie vedenia (1). (6.2)

! Skontrolujte stabilitu sušičky po otvorení jej nôh.

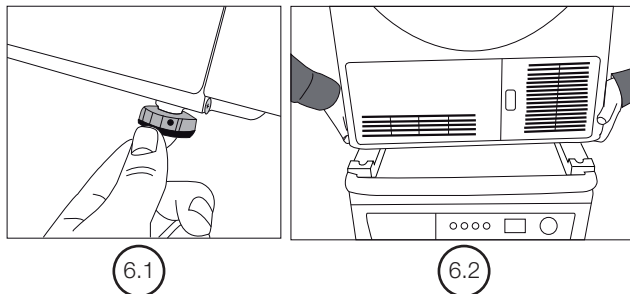

KROK č. 7 :

Potiahnite sušičku vpred na pridržiavacích vedeniach (1). (7.1)

Pokračujte v ťahaní chladničky, kým nohy nezapadnú a nezaistia sa v drážke pridržiavacieho vedenia (1). (7.2)

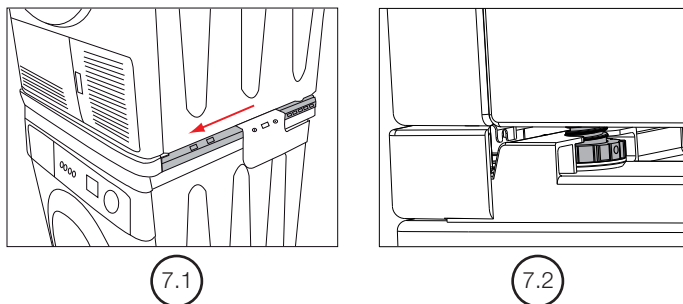

KROK č. 8 :

Odstráňte PT skrutky zo zadnej strany tela sušičky, ako je znázornené na obrázku, z ľavej aj pravej strany. Tieto skrutky budú použité neskôr. (8.1)

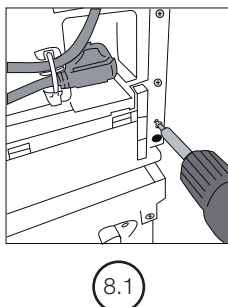

KROK č. 9 :

Pripojenie sušičky a Stohovacej sady;

- Lift the TD by pushing it forward from the rear area. Install the rear fixing part (4) to retaining duct (1) part. (9.1)

 Zadné podporné diely majú dva typy (4a, 4b) : ľavé a pravé. Montáž v opačnom smere nie je možný. Vzhľadom k tomu, že zadné podporné diely sú navrhnuté ako ľavé a pravé. (4a-4b)

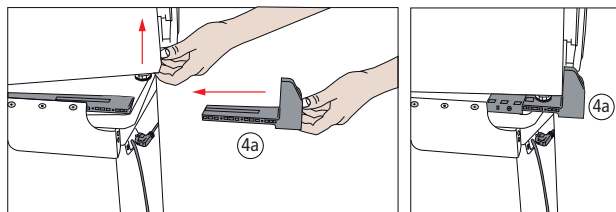

9.1

9.2

KROK č. 10 :

Posuňte zadné upevňovacie časti (4a, 4b) do vnútra pridržiavacieho vedenia (1a-1b) do hĺbky ako je sušička.

- Po tomto nastavení, pomocou skrutiek vyňatých v kroku 8 zabezpečte zadné upevňovacie diely na telo sušičky.(10.1)

 Elektrické skrutkovače použite iba v prípade skrutkových spoj.

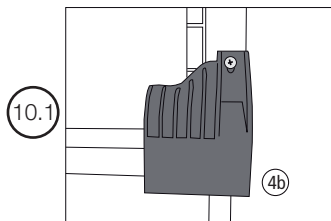

KROK č. 11 :

Pre dokončenie spojenia práčky, sušičky a Stohovacej sady;

- Prisuňte k sebe prislúchajúce otvory medzi časťami 1 a 3 a spojte ich plastovými skrutkami (2). (11.1)

- Dokončite inštaláciu Stohovacej sady vykonaním tohto postupu v oboch smeroch.

